

2008



## **GUARNIZIONI STANDARD PER SERRAMENTI IN ALLUMINIO**

**STANDARD SEALS  
FOR ALUMINIUM DOORS AND WINDOWS**

**JOINTS POUR L'ETANCHEITE  
DES FENETRES ET PORTES EN ALUMINIUM**

**STANDARD-DICHTUNGEN  
FÜR ALU-TÜREN UND -FENSTER**

**JUNTAS PARA VENTANAS DE ALUMINIO**

pensato e  
prodotto  
in Italia

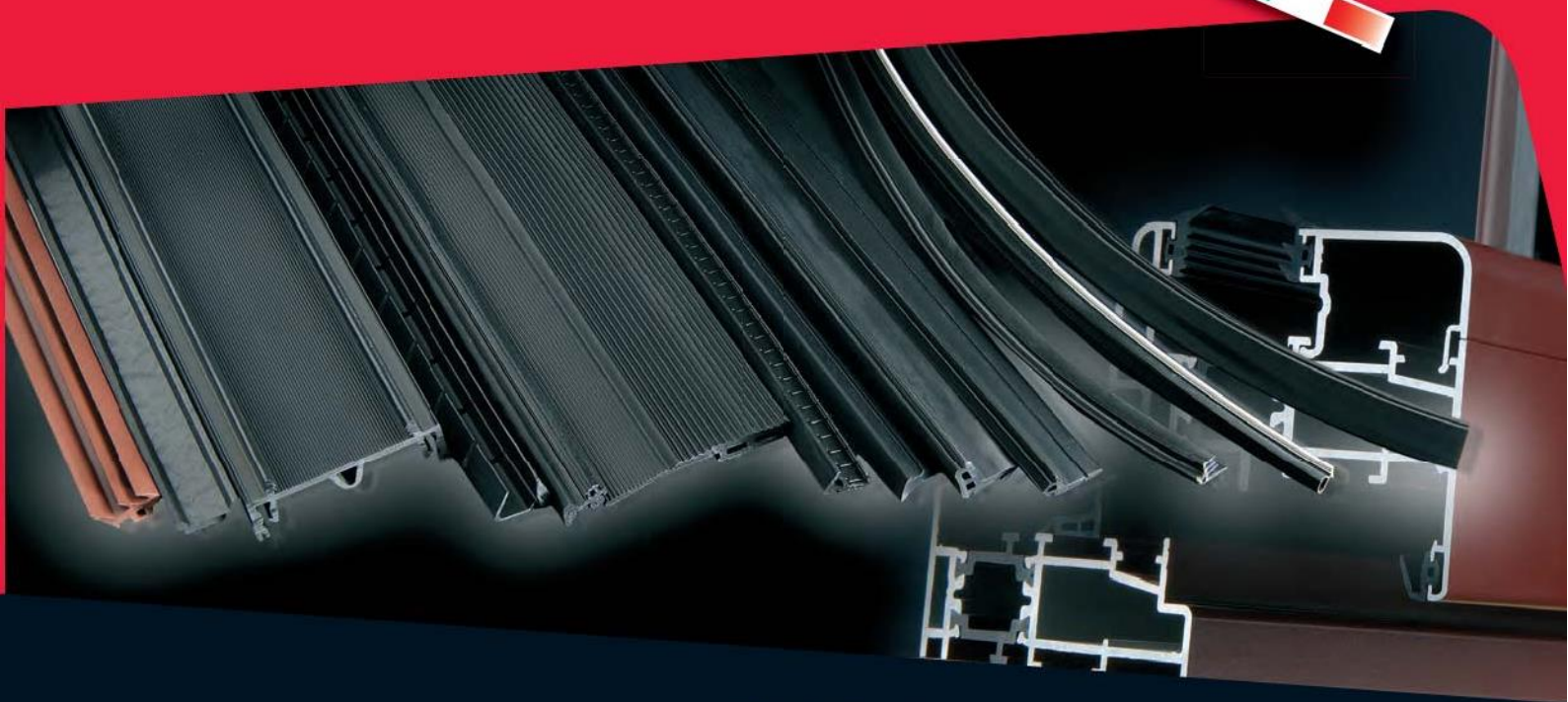

# **BMP**

## **ALUMINIUM FRAMES**

### **Materials**

All the products we use in the production are selected and tested in our chemical laboratory and come only from certified suppliers. Their common denominator is the extremely high aging resistance that ensures that the original features of the extruded ingredients remain unchanged over time. Particular attention has been paid to the development and production of special materials that meet the applicable European rules for different applications.

The BMP has highly trained technicians who are ready to help customers with designing, defining the most suitable materials, studying for the ideal color matching and producing the extrusion parts.

### **ESAFLEX**

Series of flexible materials based on PVC (polyvinyl chloride) and abbreviation "F". It has been developed according to the different degrees of hardness of the Shore A scale and meets the requirements for various applications. This broad and tested series meets UNI 9122.

### **EsaflexNgo**

This type of material is specially designed by our company to produce glamorous profiles that come around panels. It can be applied around panels with different rays and resists aging for more than 10 years without significant changes in its physical and mechanical characteristics. As a material it can be welded and glued.

### **DURFLEX**

Series of co-extruded products with the abbreviation "C", derived from a simultaneous extrusion of two plastic materials (ESADUR + ESAFLEX) with different features of hardness and flexibility. The high quality of these products allows different solutions in different applications.

### **ESADUR**

Series of rigid materials based on PVC (polyvinyl chloride) and abbreviation "R". They differ from others in terms of their impact strength. They are non-flammable, acid resistant, with low thermal expansion and low thermal conductivity coefficients.

### **ELAPRENE**

Product line with abbreviated "EL", derived from thermoplastic and thermosetting elastomer. They can be monofilament or co-extruded and meet the UNI 9122 regulation. They are perfectly resistant to extreme temperature conditions (from -30oC to + 85oC). Their main feature is the particularly high resilient resilience as tires, as confirmed by the Compression test. Elaprene is also indicated for use with water-soluble dyes.

## **EPDM Va.Le gruppo BMP**

Product line of vulcanized EPDM rubber, abbreviated as "DU" and "CS" (expanded EPDM). They offer excellent physical and mechanical characteristics to ensure maximum results in terms of the UNI 9122 standard. They have excellent resistance to oxidation, infrared UV, and atmospheric agents in general. The top softness of the expanded material allows maximum adhesion to the joint.

## **SILENE**

The silicone rubber product line, abbreviated as "SI", complies with UNI 9122. This material is considered to be the top in terms of performance. It exhibits high elastic recovery, high resistance to atmospheric agents and ensures high functionality at extreme temperatures (from -40 ° C to + 100 ° C). Silene are also indicated for applications in contact with silicone sealants.

## **ESANYL**

Series of materials with an abbreviation "N", based on polyamide 6,6 and reinforced with fiber glass to be suitable for the production of thermal cutting profile and for locking mechanisms of aluminum frames. It has excellent thermo-mechanical characteristics and makes it possible to produce profiles with narrow dimensional tolerances.

## **Blocking Test**

In order to test the actual effect of a dyeing system on a gasket, it is appropriate to evaluate - in addition to any modification of mechanical features - and any change in the functionality of the gasket.

Under certain time and temperature conditions, sticking phenomena may occur between the gasket and the window panel. This phenomenon is known as Blocking.

BMP has developed its own method for analyzing Blocking, taking into account "time", "temperature" and "contact pressure" as basic parameters.

## **Blocking Test Method**

A flat gasket sample is pressed between two pieces of wood dyed with water diluted.

A weight of 150 grams / cm<sup>2</sup> is placed at the top.

Together they enter the oven for 168 hours at + 80oC.

During the test there is no glue between the gasket and the frame painted with water diluted.

Products:

**DU** EPDM Corners (UNI 9122)

**EL** ELAPRENE Rubber Gaskets (UNI 9122/A)

**C** PVC Co-extrusion Rubber Gaskets

**F** PVC Flexible Rubber Gaskets (UNI 9122)

**R** PVC Rigid Rubber Gaskets

**ΝΕΕΣ ΣΕΙΡΕΣ**

**ΣΦΗΝΑ DH σε EPDM**

κατάλληλη & για εξωτερική χρήση

**ΣΦΗΝΑ F σε PVC**

συμφέρουσα και πολυχρηστική

- > εύκαμπτα προϊόντα
- > τοποθετούνται ταχύτατα
- > άριστο κράτημα

	Ε	Ε	Ε	Ε	Ε	Ε	Ε	Ε
ΣΕΙΡΑ DH	DH 812	DH 813	DH 814	DH 815	DU 86	DH 817	DH 818	DH 810
ΣΕΙΡΑ F200	F202	F203	F204	F205	F206	F207	F208	F210
	2 mm	3 mm	4 mm	5 mm	6 mm	7 mm	8 mm	10 mm

- > άριστες επιδόσεις  
 χάρη στην υψηλή  
 ποιότητα των προϊόντων

**εγγύηση BMP  
 εμπιστευτείτε  
 τους πρωτοπόρους**

# EFFERI

**Σφήνες EPDM για γρήγορη  
τοποθέτηση & άριστη στεγανότητα**

**Τοποθέτηση στις 45° (μοίρες)  
χωρίς κόψιμο & χρήση κόλλας**

**Ευκολία στην τοποθέτηση  
χάρη στο αποκλειστικό  
εργαλείο FPA**

**Άριστο κράτημα  
& άριστη στεγανότητα**

**Καλύτερο αισθητικό  
αποτέλεσμα**



gruppo **BMP**

# ΕΦΕΡΙ

## Κερδίστε χρόνο τοποθέτησης και εγγύηση στεγανότητας

- Οι χρόνοι τοποθέτησης μειώνονται σημαντικά χάρη στην χρήση του εργαλείου FPA, το οποίο έχει μελετηθεί ειδικά για την τοποθέτηση των σφηνών
- Το τελικό αισθητικό αποτέλεσμα είναι άριστο καθώς:
  - ▶ Δεν κόβουμε το ελαστικό σε 45° (μοίρες) στις γωνίες του κουφώματος
  - ▶ Δεν χρησιμοποιούμε κόλλα στις γωνίες του κουφώματος με κίνδυνο να ξεκολλήσει ή να μην εφαρμόσει σωστά το ελαστικό.
- Πετυχαίνουμε άριστο κράτημα και άριστη στεγανότητα από αέρα και νερό.

## ΟΙ ΚΩΔΙΚΟΙ ΤΗΣ ΣΕΙΡΑΣ

	κωδικός	εφαρμογή	συσκευασία
	FP 23	για χώρο 2,5 - 3mm	200m
	FP 45	για χώρο 4-5mm	200m
	FP 67	για χώρο 6-7mm	150m
	FPA	εργαλείο για τοποθέτηση κάθε τύπου σφήνας	10τμχ

## ΣΥΣΤΗΜΑ ΤΟΠΟΘΕΤΗΣΗΣ

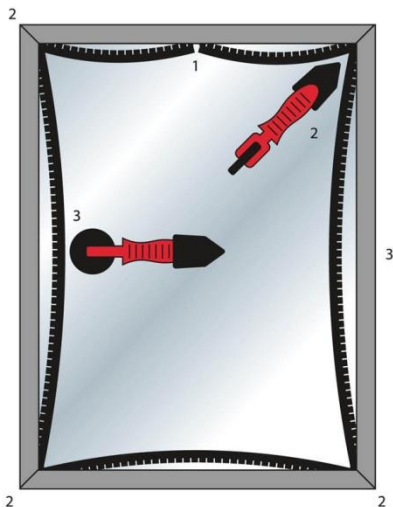

- 1 Ξεκινάμε την τοποθέτηση του ελαστικού απ' το κέντρο της ψηλότερης πλευράς του κουφώματος.
- 2 Πιέζουμε το ελαστικό στις 4 γωνίες χρησιμοποιώντας την κατάλληλη μυτερή πλευρά του εργαλείου FPA.
- 3 Πιέζουμε το ελαστικό στις 4 πλευρές ξεκινώντας από το κέντρο κάθε πλευράς και χρησιμοποιώντας το κυλινδρικό κομμάτι του εργαλείου FPA.
- 4 Ενώνουμε τα δύο άκρα του ελαστικού χρησιμοποιώντας την κυανοακρυλική κόλλα.

Υ.Γ. Το μήκος του ελαστικού πρέπει να είναι 2-3% μεγαλύτερο της περιμέτρου του κουφώματος.



gruppo **BMP**

**BMP Πλαστικά Ελλάδος Α.Ε.**

Βιομηχανία Παραγωγής Ελαστικών Παρεμβυσμάτων

ΒΙ.ΠΕ. Σερρών Τ.Κ. 621 10

Τηλ.: +30 23210 77088

FAX: +30 23210 77089

e-mail: bmpgr@otenet.gr



**Bertelli Materie Plastiche S.p.A.**

via Biella 26

20025 Legnano (MI) - Italy

tel. +39 0331 57391 - fax +39 0331 453890

e-mail: ced@bmp.it

**divisione VA.LE** estrusi in gomma e stampati  
via Molinello 99

21048 Solbiate Arno (VA) - Italy

tel. +39 0331 98671 - fax +39 0331 992230

e-mail: vale@bmp.it

**www.bmp.it**

# GLAZING GASKETS

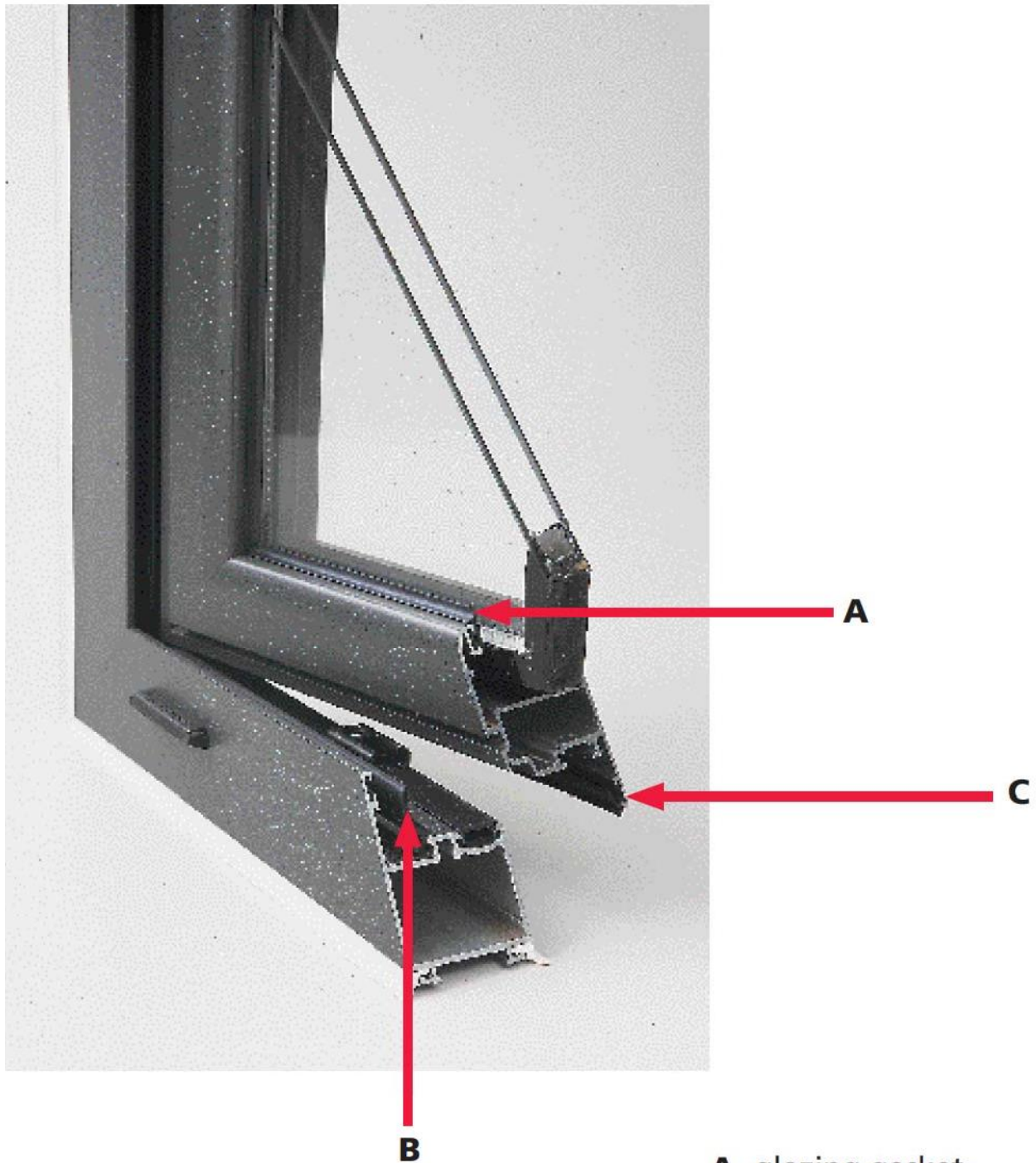

- A** glazing gasket
- B** central beating gasket
- C** inside beating gasket

# GLAZING GASKETS DU Series

**LEGEND**







- DU** seals in EPDM in conformity with the UNI 9122 regulation
- EL** seals in ELAPRENE in conformity with the UNI 9122/A regulation
- C** coextruded seals in PVC
- F** flexible seals in PVC in conformity with the UNI 9122 regulation
- R** rigid profiles in PVC

**ATTENTION:** according to standardization of packages, the size and the meter quantity may be subject to change.

\*in stock

section	product specification
<b>F</b>	<p><b>ARTICLE:</b> DU 12*</p> <p><b>WORKING FIELD:</b> 2 mm</p> <p><b>PACKAGE:</b> Rolls in boxes 600 m</p> <div style="text-align: right;"><b>NEW</b></div>
<b>F</b>	<p><b>ARTICLE:</b> DU 13*</p> <p><b>WORKING FIELD:</b> 3 mm</p> <p><b>PACKAGE:</b> Rolls in boxes 400 m</p> <div style="text-align: right;"><b>NEW</b></div>
<b>F</b>	<p><b>ARTICLE:</b> DU 14*</p> <p><b>WORKING FIELD:</b> 4 mm</p> <p><b>PACKAGE:</b> Rolls in boxes 300 m</p> <div style="text-align: right;"><b>NEW</b></div>
<b>F</b>	<p><b>ARTICLE:</b> DU 15*</p> <p><b>WORKING FIELD:</b> 5 mm</p> <p><b>PACKAGE:</b> Rolls in boxes 200 m</p> <div style="text-align: right;"><b>NEW</b></div>
<b>F</b>	<p><b>ARTICLE:</b> DU 16*</p> <p><b>WORKING FIELD:</b> 6 mm</p> <p><b>PACKAGE:</b> Rolls in boxes 150 m</p> <div style="text-align: right;"><b>NEW</b></div>
<b>F</b>	<p><b>ARTICLE:</b> DU 17*</p> <p><b>WORKING FIELD:</b> 7 mm</p> <p><b>PACKAGE:</b> Rolls in boxes 120 m</p> <div style="text-align: right;"><b>NEW</b></div>

# GLAZING GASKETS DU Series

section	product specification	
	<b>ARTICLE:</b> <b>WORKING FIELD:</b> <b>PACKAGE:</b>	<b>DU 20*</b> 2 mm Rolls in boxes 200 m
	<b>ARTICLE:</b> <b>WORKING FIELD:</b> <b>PACKAGE:</b>	<b>DU 34*</b> 3 ÷ 4 mm Rolls in boxes 200 m
	<b>ARTICLE:</b> <b>WORKING FIELD:</b> <b>PACKAGE:</b>	<b>DU 56*</b> 5 ÷ 6 mm Rolls in boxes 100 m
	<b>ARTICLE:</b> <b>WORKING FIELD:</b> <b>PACKAGE:</b>	<b>DU 78*</b> 7 ÷ 8 mm Rolls in boxes 100 m
	<b>ARTICLE:</b> <b>WORKING FIELD:</b> <b>PACKAGE:</b>	<b>DU 90*</b> 9 mm Rolls in boxes 80 m
	<b>ARTICLE:</b> <b>WORKING FIELD:</b> <b>PACKAGE:</b>	<b>DU 152*</b> 2 mm Rolls in boxes 200 m
	<b>ARTICLE:</b> <b>WORKING FIELD:</b> <b>PACKAGE:</b>	<b>DU 153*</b> 3 mm Rolls in boxes 200 m

◦ thickness from 0,7 mm to 3,5 mm

# GLAZING GASKETS DU Series

section	product specification
	<p><b>ARTICLE:</b> DU 154*</p> <p><b>WORKING FIELD:</b> 4 mm</p> <p><b>PACKAGE:</b> Rolls in boxes 200 m</p>
	<p><b>ARTICLE:</b> DU 155*</p> <p><b>WORKING FIELD:</b> 5 mm</p> <p><b>PACKAGE:</b> Rolls in boxes 150 m</p>
	<p><b>ARTICLE:</b> DU 156*</p> <p><b>WORKING FIELD:</b> 6 mm</p> <p><b>PACKAGE:</b> Rolls in boxes 150 m</p>
	<p><b>ARTICLE:</b> EL 15*</p> <p><b>WORKING FIELD:</b> 1 mm</p> <p><b>PACKAGE:</b> Rolls in boxes 200 m</p>

# GLAZING GASKETS F200 Series

## LEGEND







- DU** seals in EPDM in conformity with the UNI 9122 regulation
- EL** seals in ELAPRENE in conformity with the UNI 9122/A regulation
- C** coextruded seals in PVC
- F** flexible seals in PVC in conformity with the UNI 9122 regulation
- R** rigid profiles in PVC

**ATTENTION:** according to standardization of packages, the size and the meter quantity may be subject to change.

\*in stock

section	product specification
<b>F</b>	<p><b>ARTICLE:</b> F 202*</p> <p><b>WORKING FIELD:</b> 2 mm</p> <p><b>PACKAGE:</b> Rolls in boxes 1000 m</p> <div style="text-align: right;"></div>
<b>F</b>	<p><b>ARTICLE:</b> F 203*</p> <p><b>WORKING FIELD:</b> 3 mm</p> <p><b>PACKAGE:</b> Rolls in boxes 600 m</p> <div style="text-align: right;"></div>
<b>F</b>	<p><b>ARTICLE:</b> F 204*</p> <p><b>WORKING FIELD:</b> 4 mm</p> <p><b>PACKAGE:</b> Rolls in boxes 500 m</p> <div style="text-align: right;"></div>
<b>F</b>	<p><b>ARTICLE:</b> F 205*</p> <p><b>WORKING FIELD:</b> 5 mm</p> <p><b>PACKAGE:</b> Rolls in boxes 360 m</p> <div style="text-align: right;"></div>
<b>F</b>	<p><b>ARTICLE:</b> F 206*</p> <p><b>WORKING FIELD:</b> 6 mm</p> <p><b>PACKAGE:</b> Rolls in boxes 250 m</p> <div style="text-align: right;"></div>
<b>F</b>	<p><b>ARTICLE:</b> F 207*</p> <p><b>WORKING FIELD:</b> 7 mm</p> <p><b>PACKAGE:</b> Rolls in boxes 200 m</p> <div style="text-align: right;"></div>

# GLAZING GASKETS F200 Series

section	product specification
	<p><b>ARTICLE:</b> F 208*  <b>WORKING FIELD:</b> 8 mm  <b>PACKAGE:</b> Rolls in boxes 160 m</p> 
	<p><b>ARTICLE:</b> F 210*  <b>WORKING FIELD:</b> 10 mm  <b>PACKAGE:</b> Rolls in boxes 140 m</p> 
	<p><b>ARTICLE:</b> C 594*  <b>WORKING FIELD:</b> 2 mm  <b>PACKAGE:</b> Rolls in boxes 400 m</p>
	<p><b>ARTICLE:</b> EL 15*  <b>WORKING FIELD:</b> 1 mm  <b>PACKAGE:</b> Rolls in boxes 200 m</p>

# TRANSPARENT GLAZING GASKETS

## F300 Series

### LEGEND

**DU** seals in EPDM in conformity with the UNI 9122 regulation

**EL** seals in ELAPRENE in conformity with the UNI 9122/A regulation

**C** coextruded seals in PVC

**F** flexible seals in PVC in conformity with the UNI 9122 regulation

**R** rigid profiles in PVC

**ATTENTION:** according to standardization of packages, the size and the meter quantity may be subject to change.





\*in stock

section	product specification		
<b>F</b>	<b>ARTICLE:</b> <b>WORKING FIELD:</b> <b>COLOURS:</b> <b>PACKAGE:</b>	<b>F 302*</b> 2 mm Transparent Rolls in boxes 500 m	<b>NEW</b>
<b>F</b>	<b>ARTICLE:</b> <b>WORKING FIELD:</b> <b>COLOURS:</b> <b>PACKAGE:</b>	<b>F 303*</b> 3 mm Transparent Rolls in boxes 360 m	<b>NEW</b>
<b>F</b>	<b>ARTICLE:</b> <b>WORKING FIELD:</b> <b>COLOURS:</b> <b>PACKAGE:</b>	<b>F 304*</b> 4 mm Transparent Rolls in boxes 250 m	<b>NEW</b>
<b>F</b>	<b>ARTICLE:</b> <b>WORKING FIELD:</b> <b>COLOURS:</b> <b>PACKAGE:</b>	<b>F 305*</b> 5 mm Transparent Rolls in boxes 200 m	<b>NEW</b>
<b>F</b>	<b>ARTICLE:</b> <b>WORKING FIELD:</b> <b>COLOURS:</b> <b>PACKAGE:</b>	<b>F 306*</b> 6 mm Transparent Rolls in boxes 150 m	<b>NEW</b>
<b>F</b>	<b>ARTICLE:</b> <b>WORKING FIELD:</b> <b>COLOURS:</b> <b>PACKAGE:</b>	<b>F 307*</b> 7 mm Transparent Rolls in boxes 100 m	<b>NEW</b>



# TRANSPARENT GLAZING GASKETS

## F300 Series

section	product specification
	<p><b>ARTICLE:</b> F 308*</p> <p><b>WORKING FIELD:</b> 8 mm</p> <p><b>COLOURS:</b> Transparent</p> <p><b>PACKAGE:</b> Rolls in boxes 100 m</p> 
	<p><b>ARTICLE:</b> F 310*</p> <p><b>WORKING FIELD:</b> 10 mm</p> <p><b>COLOURS:</b> Transparent</p> <p><b>PACKAGE:</b> Rolls in boxes 80 m</p> 

# GLAZING GASKETS F1500 Series

## for wood-aluminium frames - brown colour

### LEGEND

- DU** seals in EPDM in conformity with the UNI 9122 regulation
- EL** seals in ELAPRENE in conformity with the UNI 9122/A regulation
- C** coextruded seals in PVC
- F** flexible seals in PVC in conformity with the UNI 9122 regulation
- R** rigid profiles in PVC

**ATTENTION:** according to standardization of packages, the size and the meter quantity may be subject to change.

\*in stock





section	product specification
	<p><b>ARTICLE:</b> F 1503*</p> <p><b>WORKING FIELD:</b> 3 mm</p> <p><b>COLOURS:</b> Brown</p> <p><b>PACKAGE:</b> Rolls in boxes 250 m</p> <div style="text-align: right;"></div>
	<p><b>ARTICLE:</b> F 1504*</p> <p><b>WORKING FIELD:</b> 4 mm</p> <p><b>COLOURS:</b> Brown</p> <p><b>PACKAGE:</b> Rolls in boxes 200 m</p> <div style="text-align: right;"></div>
	<p><b>ARTICLE:</b> F 1505*</p> <p><b>WORKING FIELD:</b> 5 mm</p> <p><b>COLOURS:</b> Brown</p> <p><b>PACKAGE:</b> Rolls in boxes 150 m</p> <div style="text-align: right;"></div>
	<p><b>ARTICLE:</b> F 1506*</p> <p><b>WORKING FIELD:</b> 6 mm</p> <p><b>COLOURS:</b> Brown</p> <p><b>PACKAGE:</b> Rolls in boxes 140 m</p> <div style="text-align: right;"></div>
	<p><b>ARTICLE:</b> F 1508*</p> <p><b>WORKING FIELD:</b> 8 mm</p> <p><b>COLOURS:</b> Brown</p> <p><b>PACKAGE:</b> Rolls in boxes 90 m</p> <div style="text-align: right;"></div>

# EFFEPI EPDM precut gasket

**ATTENTION:** according to standardization of packages, the size and the meter quantity may be subject to change.

\*in stock

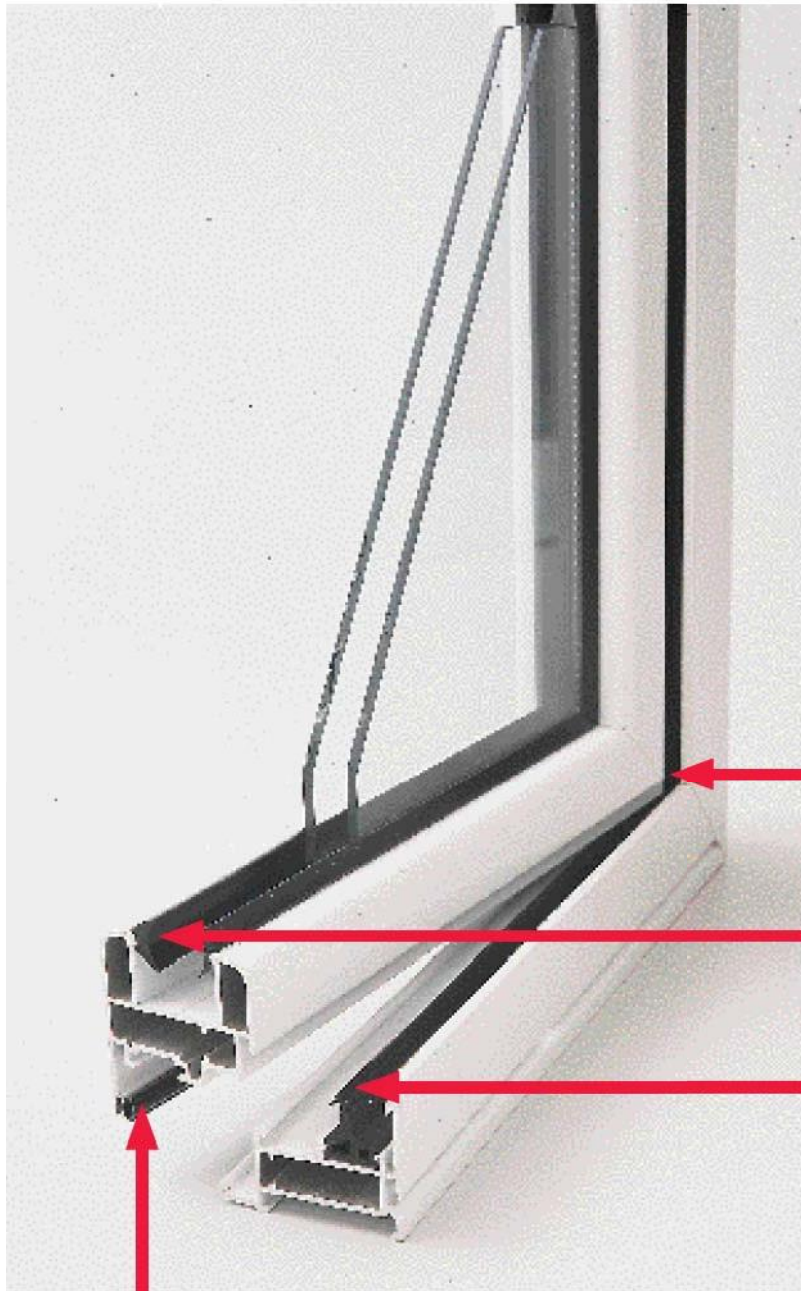

section	product specification	
	<b>ARTICLE:</b> <b>WORKING FIELD:</b> <b>PACKAGE:</b>	<b>FP 23*</b> 2.5 ÷ 3 mm Rolls in boxes 200 m
	<b>ARTICLE:</b> <b>WORKING FIELD:</b> <b>PACKAGE:</b>	<b>FP 45*</b> 4 ÷ 5 mm Rolls in boxes 200 m
	<b>ARTICLE:</b> <b>WORKING FIELD:</b> <b>PACKAGE:</b>	<b>FP 67*</b> 6 ÷ 7 mm Rolls in boxes 150 m
	<b>ARTICLE:</b> <b>PACKAGE:</b>	<b>FPA*</b> - Tool for gasket application 10 pieces

**ALCAN****C**

- A** glazing gasket
- B** central beating gasket
- C** inside beating gasket
- D** vulcanized angle





# ALCAN

**LEGEND**



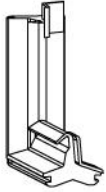

- DU** seals in EPDM in conformity with the UNI 9122 regulation
- EL** seals in ELAPRENE in conformity with the UNI 9122/A regulation
- C** coextruded seals in PVC
- F** flexible seals in PVC in conformity with the UNI 9122 regulation
- R** rigid profiles in PVC

**ATTENTION:** according to standardization of packages, the size and the meter quantity may be subject to change.

\*in stock

section	product specification	
	<b>SERIES:</b> GREEN <b>ARTICLE:</b> <b>DU 800*</b> <b>PACKAGE:</b> Kinks in boxes 120 m	
	<b>SERIES:</b> GREEN <b>ARTICLE:</b> <b>DU 2006*</b> - Angle for DU 800 <b>DIMENSIONS:</b> 50 x 50 mm <b>PACKAGE:</b> Small boxes of 1320 pieces	
	<b>SERIES:</b> GREEN <b>ARTICLE:</b> <b>DU 805</b> <b>PACKAGE:</b> Rolls in boxes 300 m	
	<b>SERIES:</b> GREEN <b>ARTICLE:</b> <b>C 825*</b> <b>PACKAGE:</b> Rolls in boxes 600 m	<b>EL 10*</b> Rolls in boxes 600 m
	<b>SERIES:</b> GREEN <b>ARTICLE:</b> <b>DU 210*</b> <b>PACKAGE:</b> Rolls in boxes 300 m	
	<b>SERIES:</b> GREEN <b>ARTICLE:</b> <b>DU 810</b> <b>WORKING FIELD:</b> 3.5 mm <b>PACKAGE:</b> Rolls in boxes 200 m	

# ALCAN

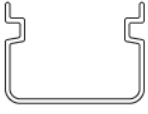
section	product specification	
	<b>SERIES:</b> <b>ARTICLE:</b> <b>WORKING FIELD:</b> <b>PACKAGE:</b>	GREEN <b>DU 152*</b> 2 mm Rolls in boxes 200 m
	<b>SERIES:</b> <b>ARTICLE:</b> <b>WORKING FIELD:</b> <b>PACKAGE:</b>	GREEN <b>DU 153*</b> 3 mm Rolls in boxes 200 m
	<b>SERIES:</b> <b>ARTICLE:</b> <b>WORKING FIELD:</b> <b>PACKAGE:</b>	GREEN <b>DU 154*</b> 4 mm Rolls in boxes 200 m
	<b>SERIES:</b> <b>ARTICLE:</b> <b>WORKING FIELD:</b> <b>PACKAGE:</b>	GREEN <b>DU 155*</b> 5 mm Rolls in boxes 150 m
	<b>SERIES:</b> <b>ARTICLE:</b> <b>WORKING FIELD:</b> <b>PACKAGE:</b>	GREEN <b>DU 156*</b> 6 mm Rolls in boxes 150 m
	<b>SERIES:</b> <b>ARTICLE:</b> <b>PACKAGE:</b>	GREEN <b>R 2205*</b> Boxes of 100 bars 3000 mm

**NEW**

# ALCOA

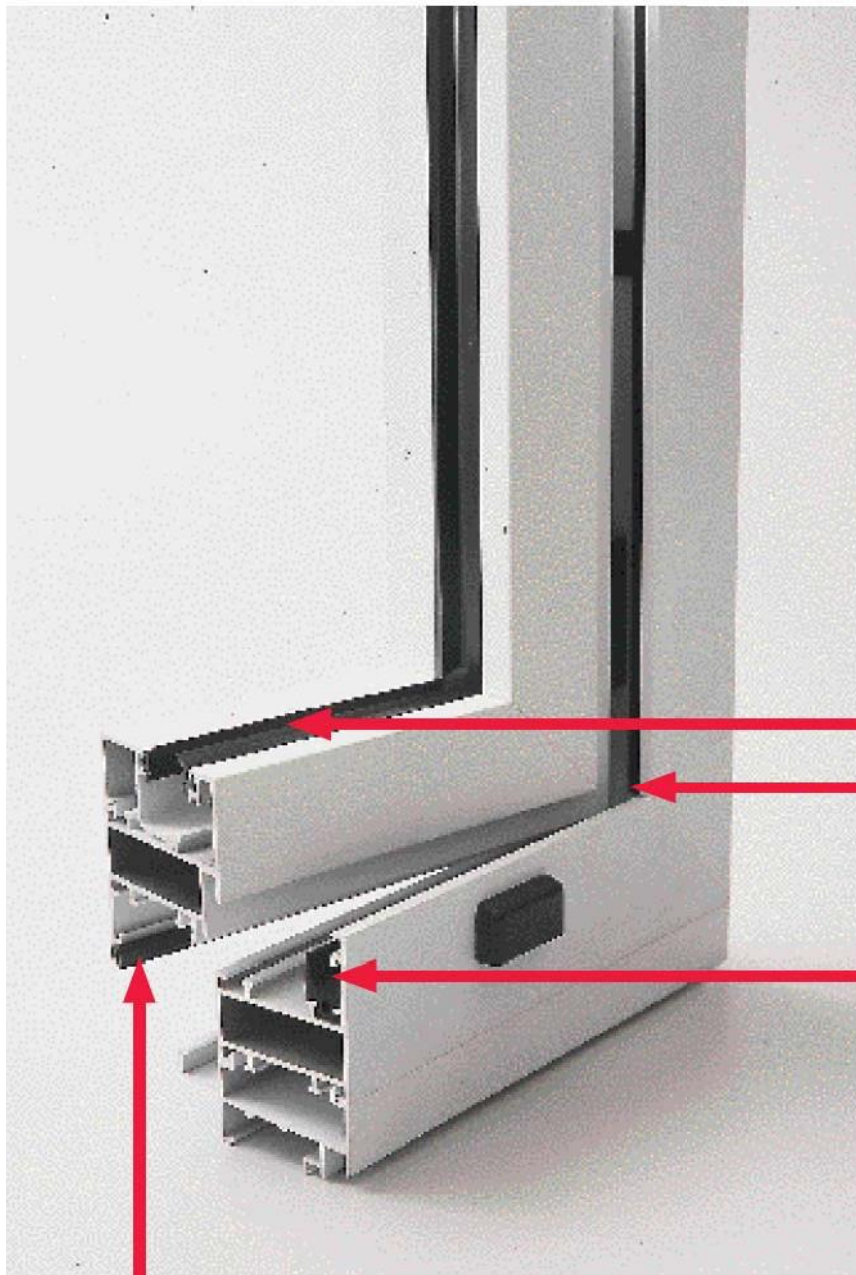
**C**

- A** glazing gasket
- B** central beating gasket
- C** inside beating gasket
- D** vulcanized angle





# ALCOA

## LEGEND

- DU** seals in EPDM in conformity with the UNI 9122 regulation
- EL** seals in ELAPRENE in conformity with the UNI 9122/A regulation
- C** coextruded seals in PVC
- F** flexible seals in PVC in conformity with the UNI 9122 regulation
- R** rigid profiles in PVC

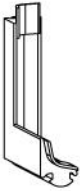

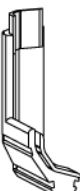



**ATTENTION:** according to standardization of packages, the size and the meter quantity may be subject to change.

\*in stock

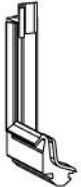

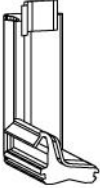

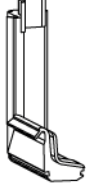

section	product specification	
	<b>SERIES:</b> R 40 - R 50 <b>ARTICLE:</b> <b>DU 200*</b> <b>PACKAGE:</b> Kinks in boxes 150 m	
	<b>SERIES:</b> R 40 - R 50 <b>ARTICLE:</b> <b>DU 2005*</b> - Angle for DU 200 <b>DIMENSIONS:</b> 60 x 60 mm <b>PACKAGE:</b> Small boxes of 1500 pieces	
	<b>SERIES:</b> R 40 - R 50 <b>ARTICLE:</b> <b>DU 201*</b> <b>PACKAGE:</b> Kinks in boxes 150 m	
	<b>SERIES:</b> R 40 REVAMPING <b>ARTICLE:</b> <b>DU 202*</b> <b>PACKAGE:</b> Kinks in boxes 180 m	
	<b>SERIES:</b> R 40 REVAMPING <b>ARTICLE:</b> <b>DU 2058*</b> - Angle for DU 202 <b>DIMENSIONS:</b> 40 x 40 mm <b>PACKAGE:</b> Small boxes of 3360 pieces	
	<b>SERIES:</b> R 40 - R 50 <b>ARTICLE:</b> <b>F 894</b> <b>PACKAGE:</b> Rolls in boxes 200 m	<b>DU 1095</b> Rolls in boxes 150 m



# ALCOA

section	product specification	
	<b>SERIES:</b> <b>ARTICLE:</b> <b>DIMENSIONS:</b> <b>PACKAGE:</b>	R 40 - R 50 <b>DU 2012*</b> - Angle for DU 1095 45 x 45 mm Small boxes of 1200 pieces
	<b>SERIES:</b> <b>ARTICLE:</b> <b>PACKAGE:</b>	R 60 T.T. <b>DU 251*</b> Kinks in boxes 120 m
	<b>SERIES:</b> <b>ARTICLE:</b> <b>DIMENSIONS:</b> <b>PACKAGE:</b>	R 60 T.T. <b>DU 2018*</b> - Angle for DU 251 50 x 50 mm Small boxes of 720 pieces
	<b>SERIES:</b> <b>ARTICLE:</b> <b>PACKAGE:</b>	NEW R 50 T.T.. - R 72 T.T <b>DU 1303*</b> Kinks in boxes 150 m
	<b>SERIES:</b> <b>ARTICLE:</b> <b>DIMENSIONS:</b> <b>PACKAGE:</b>	NEW R 50 T.T.. - R 72 T.T <b>DU 2029*</b> - Angle for DU 1303 55 x 55 mm Small boxes of 1500 pieces
	<b>SERIES:</b> <b>ARTICLE:</b> <b>PACKAGE:</b>	R 62 T.T. <b>DU 1553</b> Kinks in boxes 150 m
	<b>SERIES:</b> <b>ARTICLE:</b> <b>PACKAGE:</b>	R 40 - R 50 - NEW R 50 T.T. <b>C 825*</b> <b>EL 10*</b> Rolls in boxes 600 m      Rolls in boxes 600 m







# ALCOA

section	product specification	
	<b>SERIES:</b> <b>ARTICLE:</b> <b>PACKAGE:</b>	R 40 - R 50 - NEW R 50 T.T. <b>DU 210*</b> Rolls in boxes 300 m
	<b>SERIES:</b> <b>ARTICLE:</b> <b>PACKAGE:</b>	R 40 - R 50 <b>CS 3013*</b> Rolls in boxes 300 m
	<b>SERIES:</b> <b>ARTICLE:</b> <b>WORKING FIELD:</b> <b>PACKAGE:</b>	R <b>C 2122*</b> 1.5 mm Rolls in boxes 700 m
	<b>SERIES:</b> <b>ARTICLE:</b> <b>WORKING FIELD:</b> <b>PACKAGE:</b>	R <b>C 2128*</b> 3 mm Rolls in boxes 500 m
	<b>SERIES:</b> <b>ARTICLE:</b> <b>PACKAGE:</b>	GR <b>RG 36</b> - in flexible PVC Rolls in boxes 600 m
	<b>SERIES:</b> <b>ARTICLE:</b> <b>PACKAGE:</b>	GR <b>RG 36c*</b> - in coextruded PVC Rolls in boxes 1000 m
	<b>SERIES:</b> <b>ARTICLE:</b> <b>PACKAGE:</b>	R 40 - R 50 <b>C 706*</b> Rolls in boxes 350 m







**NEW**

**NEW**

# ALCOA

section	product specification
	<p><b>SERIES:</b> R 40 - R 50  <b>ARTICLE:</b> <b>C 707*</b>  <b>PACKAGE:</b> Rolls in boxes 500 m</p>
	<p><b>SERIES:</b> R 40 - R 50 - NEW R 50 T.T.  <b>ARTICLE:</b> <b>DU 152*</b>  <b>WORKING FIELD:</b> 2 mm  <b>PACKAGE:</b> Rolls in boxes 200 m</p>
	<p><b>SERIES:</b> R 40 - R 50 - NEW R 50 T.T.  <b>ARTICLE:</b> <b>DU 153*</b>  <b>WORKING FIELD:</b> 3 mm  <b>PACKAGE:</b> Rolls in boxes 200 m</p>
	<p><b>SERIES:</b> R 40 - R 50 - NEW R 50 T.T.  <b>ARTICLE:</b> <b>DU 154*</b>  <b>WORKING FIELD:</b> 4 mm  <b>PACKAGE:</b> Rolls in boxes 200 m</p>
	<p><b>SERIES:</b> R 40 - R 50 - NEW R 50 T.T.  <b>ARTICLE:</b> <b>DU 155*</b>  <b>WORKING FIELD:</b> 5 mm  <b>PACKAGE:</b> Rolls in boxes 150 m</p>
	<p><b>SERIES:</b> R 40 - R 50 - NEW R 50 T.T.  <b>ARTICLE:</b> <b>DU 156*</b>  <b>WORKING FIELD:</b> 6 mm  <b>PACKAGE:</b> Rolls in boxes 150 m</p>
	<p><b>SERIES:</b> R 40 - R 50 - NEW R 50 T.T.  <b>ARTICLE:</b> <b>DU 230*</b>  <b>WORKING FIELD:</b> 3 mm  <b>PACKAGE:</b> Rolls in boxes 150 m</p>

# ALCOA

section	product specification
	<p><b>SERIES:</b> GR  <b>ARTICLE:</b> <b>RG 27</b> - in flexible PVC  <b>PACKAGE:</b> Rolls in boxes 500 m</p>
	<p><b>SERIES:</b> GR  <b>ARTICLE:</b> <b>RG 35</b> - in flexible PVC  <b>PACKAGE:</b> Rolls in boxes 400 m</p>
	<p><b>SERIES:</b> GR  <b>ARTICLE:</b> <b>RG 38</b> - in flexible PVC  <b>PACKAGE:</b> Rolls in boxes 600 m</p>
	<p><b>SERIES:</b> R 50  <b>ARTICLE:</b> <b>DU 231*</b>  <b>WORKING FIELD:</b> 2.5 mm  <b>PACKAGE:</b> Rolls in boxes 200 m</p>
	<p><b>SERIES:</b> R 40 - R 50  <b>ARTICLE:</b> <b>C 1727*</b>  <b>PACKAGE:</b> Rolls in boxes 400 m</p>
	<p><b>SERIES:</b> R 40 - R 50  <b>ARTICLE:</b> <b>CS 3034</b>  <b>WORKING FIELD:</b> 2.5 mm  <b>PACKAGE:</b> Rolls in boxes 150 m</p>
	<p><b>SERIES:</b> R 40 - R 50 - GR  <b>ARTICLE:</b> <b>RG 44c*</b> - Under door gasket in coextruded PVC  <b>PACKAGE:</b> Rolls in boxes 300 m</p>

# ALCOA

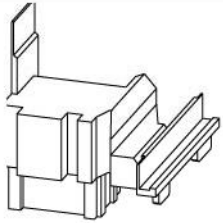
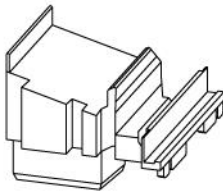
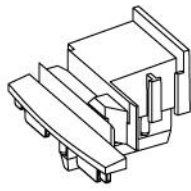
section	product specification
	<p><b>SERIES:</b> R 50 T.T. B.C.  <b>ARTICLE:</b> <b>DU 2100*</b> - Right and left cap of beating gasket reverse  <b>PACKAGE:</b> Boxes of 150 couples</p> <div style="text-align: right;"><b>NEW</b></div>
	<p><b>SERIES:</b> NEW R 50 T.T.  <b>ARTICLE:</b> <b>DU 2101*</b> - Cap for NEW R 50 T.T.  <b>PACKAGE:</b> Boxes of 150 couples</p>
	<p><b>SERIES:</b> R 40 REVAMPING  <b>ARTICLE:</b> <b>DU 2104</b> - Cap of beating gasket reverse  <b>PACKAGE:</b> Boxes of 150 couples</p>

**ALL.CO**

- A** glazing gasket
- B** central beating gasket
- C** inside beating gasket
- D** vulcanized angle

# ALL.CO

## LEGEND







- DU** seals in EPDM in conformity with the UNI 9122 regulation
- EL** seals in ELAPRENE in conformity with the UNI 9122/A regulation
- C** coextruded seals in PVC
- F** flexible seals in PVC in conformity with the UNI 9122 regulation
- R** rigid profiles in PVC

**ATTENTION:** according to standardization of packages, the size and the meter quantity may be subject to change.

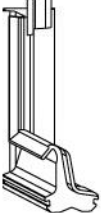
\*in stock







section	product specification	
	<p><b>SERIES:</b> ALL.CO 5  <b>ARTICLE:</b> <b>DU 600*</b>  <b>PACKAGE:</b> Rolls in boxes 150 m</p>	
	<p><b>SERIES:</b> ALL.CO 5 EXPOSURE  <b>ARTICLE:</b> <b>DU 620*</b>  <b>PACKAGE:</b> Kinks in boxes 180 m</p>	
	<p><b>SERIES:</b> ALL.CO 5 EXPOSURE  <b>ARTICLE:</b> <b>DU 2059</b> - Angle for DU 620  <b>DIMENSIONS:</b> 50 x 50 mm  <b>PACKAGE:</b> Small boxes of 2400 pieces</p>	
	<p><b>SERIES:</b> EXPORT 50 T.T.  <b>ARTICLE:</b> <b>DU 650*</b>  <b>PACKAGE:</b> Kinks in boxes 120 m</p>	
	<p><b>SERIES:</b> EXPORT 50 T.T.  <b>ARTICLE:</b> <b>DU 2035</b> - Angle for DU 650  <b>DIMENSIONS:</b> 55 x 55 mm  <b>PACKAGE:</b> Small boxes of 1200 pieces</p>	
	<p><b>SERIES:</b> EXPORT 45 T.T.  <b>ARTICLE:</b> <b>DU 651*</b>  <b>PACKAGE:</b> Kinks in boxes 120 m</p>	

# ALL.CO







section	product specification
	<p><b>SERIES:</b> EXPORT 45 T.T.  <b>ARTICLE:</b> <b>DU 2020*</b> - Angle for DU 651  <b>DIMENSIONS:</b> 50 x 50 mm  <b>PACKAGE:</b> Small boxes of 1080 pieces</p>
	<p><b>SERIES:</b> EXPORT 50  <b>ARTICLE:</b> <b>DU 660*</b>  <b>PACKAGE:</b> Kinks in boxes 150 m</p>
	<p><b>SERIES:</b> ALL.CO 5 EXPOSURE - ALL.CO 5 T.T. EXPOSURE  <b>ARTICLE:</b> <b>C 1305*</b> <b>EL 116*</b>  <b>PACKAGE:</b> Rolls in boxes 700 m      Rolls in boxes 600 m</p>
	<p><b>SERIES:</b> ALL.CO 45 T.T. EXPORT  <b>ARTICLE:</b> <b>C 1971</b>  <b>PACKAGE:</b> Rolls in boxes 600 m</p>
	<p><b>SERIES:</b> ALL.CO 5 EXPOSURE  <b>ARTICLE:</b> <b>C 1983</b>  <b>PACKAGE:</b> Rolls in boxes 400 m</p>
	<p><b>SERIES:</b> ALL.CO EXPORT 50 T.T.  <b>ARTICLE:</b> <b>DU 601</b>  <b>PACKAGE:</b> Rolls in boxes 50 m</p>
	<p><b>SERIES:</b> ALL.CO EXPORT 45 T.T.  <b>ARTICLE:</b> <b>DU 602</b>  <b>WORKING FIELD:</b> 3 ÷ 4 mm  <b>PACKAGE:</b> Rolls in boxes 100 m</p>







# ALL.CO

section	product specification	
	<p><b>SERIES:</b> <b>ARTICLE:</b> <b>WORKING FIELD:</b> <b>PACKAGE:</b></p>	<p>ALL.CO EXPORT 50 T.T. <b>DU 607</b> 3 mm Rolls in boxes 100 m</p>
	<p><b>SERIES:</b> <b>ARTICLE:</b> <b>PACKAGE:</b></p>	<p>ALL.CO EXPORT 50 T.T. <b>DU 606</b> Rolls in boxes 50 m</p>
	<p><b>SERIES:</b> <b>ARTICLE:</b> <b>PACKAGE:</b></p>	<p>ALL.CO 5 - ALL.CO 5 T.T. COMPLANER <b>C 1072*</b> Rolls in boxes 400 m</p>
	<p><b>SERIES:</b> <b>ARTICLE:</b> <b>WORKING FIELD:</b> <b>PACKAGE:</b></p>	<p>ALL.CO 5 COMPLANER - ALL.CO 5 T.T. EXPOSURE <b>DU 320*</b> 5 mm Rolls in boxes 100 m</p>
	<p><b>SERIES:</b> <b>ARTICLE:</b> <b>WORKING FIELD:</b> <b>PACKAGE:</b></p>	<p>ALL.CO 5 COMPLANER - ALL.CO 5 T.T. EXPOSURE <b>DU 355</b> 2.5 ÷ 3 mm Rolls in boxes 200 m</p>
	<p><b>SERIES:</b> <b>ARTICLE:</b> <b>WORKING FIELD:</b> <b>PACKAGE:</b></p>	<p>ALL.CO 5 COMPLANER - ALL.CO 5 T.T. EXPOSURE <b>DU 152*</b> 2 mm Rolls in boxes 200 m</p>
	<p><b>SERIES:</b> <b>ARTICLE:</b> <b>WORKING FIELD:</b> <b>PACKAGE:</b></p>	<p>ALL.CO 5 COMPLANER - ALL.CO 5 T.T. EXPOSURE <b>DU 153*</b> 3 mm Rolls in boxes 200 m</p>

# ALL.CO







section	product specification
	<p><b>SERIES:</b> ALL.CO 5 COMPLANER - ALL.CO 5 T.T. EXPOSURE  <b>ARTICLE:</b> <b>DU 154*</b>  <b>WORKING FIELD:</b> 4 mm  <b>PACKAGE:</b> Rolls in boxes 200 m</p>
	<p><b>SERIES:</b> ALL.CO 5 COMPLANER - ALL.CO 5 T.T. EXPOSURE  <b>ARTICLE:</b> <b>DU 155*</b>  <b>WORKING FIELD:</b> 5 mm  <b>PACKAGE:</b> Rolls in boxes 150 m</p>
	<p><b>SERIES:</b> ALL.CO 5 COMPLANER - ALL.CO 5 T.T. EXPOSURE  <b>ARTICLE:</b> <b>DU 156*</b>  <b>WORKING FIELD:</b> 6 mm  <b>PACKAGE:</b> Rolls in boxes 150 m</p>
	<p><b>SERIES:</b> ALL.CO 5 - ALL.CO 5 T.T.  <b>ARTICLE:</b> <b>DU 610*</b>  <b>PACKAGE:</b> Rolls in boxes 150 m</p>
	<p><b>SERIES:</b> ALL.CO 5  <b>ARTICLE:</b> <b>C 1086</b>  <b>PACKAGE:</b> Rolls in boxes 800 m</p>
	<p><b>SERIES:</b> VERANDA  <b>ARTICLE:</b> <b>EUR 73</b>  <b>PACKAGE:</b> Rolls in boxes 600 m</p>

# ALL.CO K WOOD

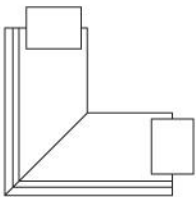
section	product specification	
	<p><b>SERIES:</b> <b>ARTICLE:</b> <b>PACKAGE:</b></p>	<p>ALL.CO K WOOD <b>DU 605</b> Kinks in boxes 180 m</p>
	<p><b>SERIES:</b> <b>ARTICLE:</b> <b>WORKING FIELD:</b> <b>PACKAGE:</b></p>	<p>ALL.CO K WOOD <b>DU 652*</b> - Glazing gasket 5 ÷ 6 mm Rolls in boxes 100 m</p>
	<p><b>SERIES:</b> <b>ARTICLE:</b> <b>WORKING FIELD:</b> <b>PACKAGE:</b></p>	<p>ALL.CO EXPORT 45 T.T. <b>DU 602</b> 3 ÷ 4 mm Rolls in boxes 100 m</p>
	<p><b>SERIES:</b> <b>ARTICLE:</b> <b>PACKAGE:</b></p>	<p>ALL.CO K WOOD <b>DU 603</b> Rolls in boxes 100 m</p>
	<p><b>SERIES:</b> <b>ARTICLE:</b> <b>PACKAGE:</b></p>	<p>ALL.CO K WOOD <b>DU 604</b> Rolls in boxes 150 m</p>

# ALL.CO WOOD

## black and brown

section	product specification	
	<b>SERIES:</b> <b>ARTICLE:</b> <b>COLOURS:</b> <b>PACKAGE:</b>	ALL.CO WOOD <b>DU 1110*</b> Black and Brown Kinks in boxes 150 m
	<b>SERIES:</b> <b>ARTICLE:</b> <b>DIMENSIONS:</b> <b>COLOURS:</b> <b>PACKAGE:</b>	ALL.CO WOOD <b>DU 2138</b> - Angle for DU 1110 40 x 40 mm Black and Brown Small boxes of 2160 pieces
	<b>SERIES:</b> <b>ARTICLE:</b> <b>WORKING FIELD:</b> <b>COLOURS:</b> <b>PACKAGE:</b>	ALL.CO WOOD <b>DU 1106*</b> 5 mm Black and Brown Rolls in boxes 100 m
	<b>SERIES:</b> <b>ARTICLE:</b> <b>COLOURS:</b> <b>PACKAGE:</b>	ALL.CO WOOD <b>DU 1107*</b> Black and Brown Rolls in boxes 150 m
	<b>SERIES:</b> <b>ARTICLE:</b> <b>COLOURS:</b> <b>PACKAGE:</b>	ALL.CO WOOD <b>DU 1108*</b> Black and Brown Rolls in boxes 100 m
	<b>SERIES:</b> <b>ARTICLE:</b> <b>COLOURS:</b> <b>PACKAGE:</b>	ALL.CO WOOD <b>DU 1109*</b> - Gasket for frame Black and Brown Rolls in boxes 50 m
	<b>SERIES:</b> <b>ARTICLE:</b> <b>COLOURS:</b> <b>PACKAGE:</b>	ALL.CO WOOD <b>DU 622*</b> Black and Brown Rolls in boxes 100 m

# ALL.CO WOOD

## black and brown

section	product specification
	<p><b>SERIES:</b> ALL.CO WOOD  <b>ARTICLE:</b> <b>F 1265*</b> - Flexible sound-insulating jointing  <b>COLOURS:</b> Black and Brown  <b>PACKAGE:</b> Kinks in boxes 150 m</p>

# EUROPA

## LEGEND

**DU** seals in EPDM in conformity with the UNI 9122 regulation

**EL** seals in ELAPRENE in conformity with the UNI 9122/A regulation

**C** coextruded seals in PVC

**F** flexible seals in PVC in conformity with the UNI 9122 regulation



**R** rigid profiles in PVC

**ATTENTION:** according to standardization of packages, the size and the meter quantity may be subject to change.

\*in stock

section	product specification	
	<b>SERIES:</b> <b>ARTICLE:</b> <b>PACKAGE:</b>	FB OPEN JOINT - BOB.2 - PLANA <b>EUR 31*</b> - in coextruded PVC Rolls in boxes 800 m
	<b>SERIES:</b> <b>ARTICLE:</b> <b>PACKAGE:</b>	BOB.1 - BOB.2 - BOB.4 - FB OPEN JOINT - K3L - PLANA <b>EUR 24*</b> - in coextruded PVC <b>EL 1</b> - in coextruded ELAPRENE Rolls in boxes 1400 m                      Rolls in boxes 1400 m
	<b>SERIES:</b> <b>ARTICLE:</b> <b>PACKAGE:</b>	FOLDING DOOR <b>EUR 73</b> - in coextruded PVC Rolls in boxes 600 m
	<b>SERIES:</b> <b>ARTICLE:</b> <b>PACKAGE:</b>	FOLDING DOOR <b>EUR 29</b> - in coextruded PVC Rolls in boxes 600 m
	<b>SERIES:</b> <b>ARTICLE:</b> <b>PACKAGE:</b>	BALKON - BOB.1 - BOB.2 - FB OPEN JOINT - PLANA <b>EUR 33*</b> - in coextruded PVC Rolls in boxes 600 m
	<b>SERIES:</b> <b>ARTICLE:</b> <b>PACKAGE:</b>	BALKON - BOB.1 - BOB.2 - FB OPEN JOINT - PLANA <b>EUR 34*</b> - in coextruded PVC Rolls in boxes 800 m

# EUROPA

section	product specification
	<p><b>SERIES:</b> BOB.4  <b>ARTICLE:</b> <b>EUR 65</b> - in flexible PVC  <b>PACKAGE:</b> Rolls in boxes 160 m</p>
	<p><b>SERIES:</b> BOB.2  <b>ARTICLE:</b> <b>EUR 9</b> - in flexible PVC - Under door gasket  <b>PACKAGE:</b> Rolls in boxes 700 m</p>
	<p><b>SERIES:</b> FB  <b>ARTICLE:</b> <b>EUR 48</b> - in coextruded PVC - Gasket for blinds  <b>PACKAGE:</b> Rolls in boxes 1500 m</p>

# HYDRO

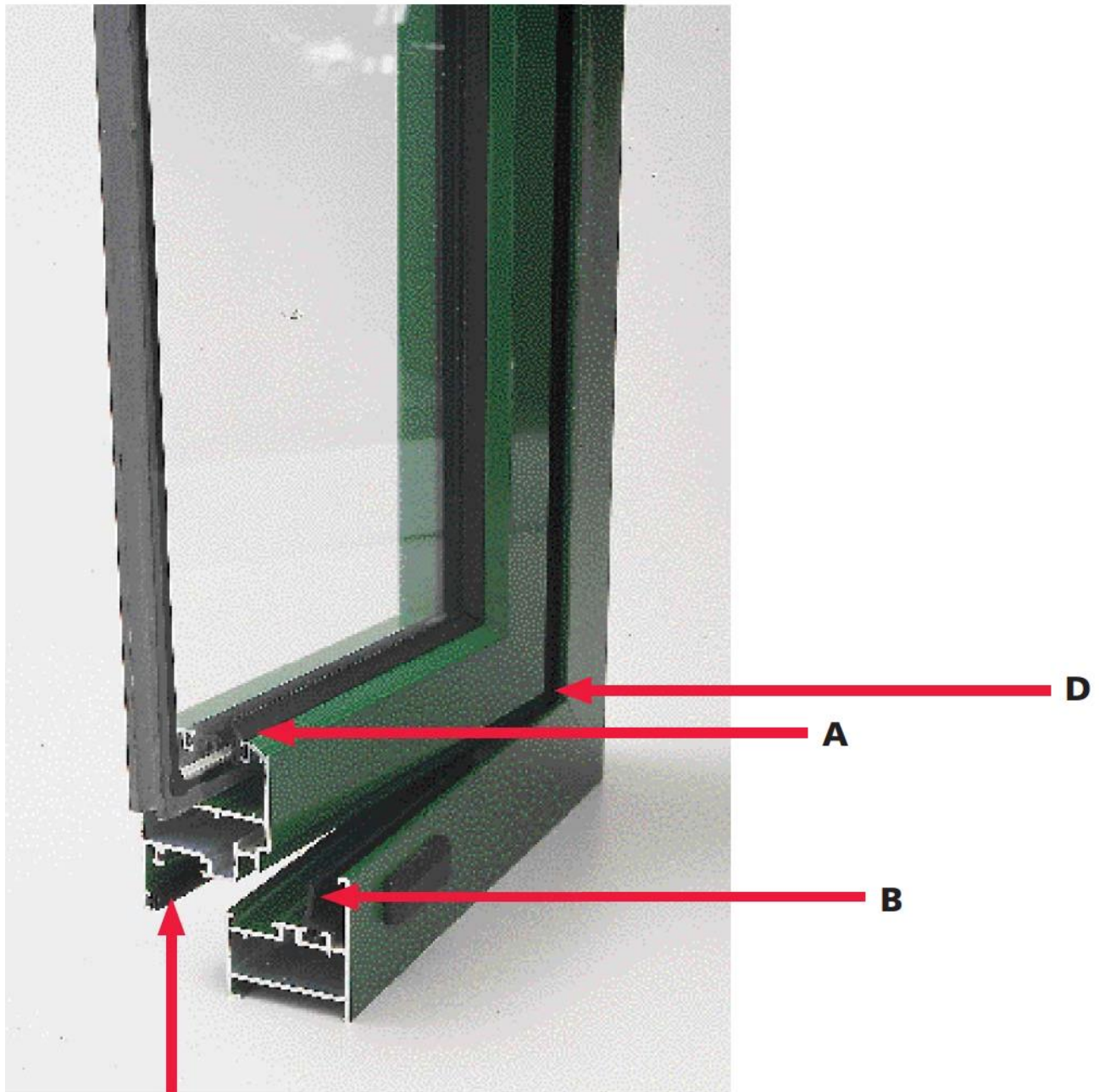

- A** glazing gasket
- B** central beating gasket
- C** inside beating gasket
- D** vulcanized angle







# HYDRO

## LEGEND





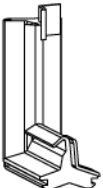

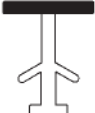
- DU** seals in EPDM in conformity with the UNI 9122 regulation
- EL** seals in ELAPRENE in conformity with the UNI 9122/A regulation
- C** coextruded seals in PVC
- F** flexible seals in PVC in conformity with the UNI 9122 regulation
- R** rigid profiles in PVC

**ATTENTION:** according to standardization of packages, the size and the meter quantity may be subject to change.







\*in stock

section	product specification	
	<b>SERIES:</b> <b>ARTICLE:</b> <b>PACKAGE:</b>	DOMAL STOPPER PG <b>DU 300*</b> Kinks in boxes 180 m
	<b>SERIES:</b> <b>ARTICLE:</b> <b>DIMENSIONS:</b> <b>PACKAGE:</b>	DOMAL STOPPER PG <b>DU 2004*</b> - Angle for DU 300 65 x 65 mm Small boxes of 1500 pieces
	<b>SERIES:</b> <b>ARTICLE:</b> <b>PACKAGE:</b>	DOMAL BREAK PA 52 <b>DU 370*</b> Kinks in boxes 100 m
	<b>SERIES:</b> <b>ARTICLE:</b> <b>DIMENSIONS:</b> <b>PACKAGE:</b>	DOMAL BREAK <b>DU 2006*</b> - Angle for DU 370 50 x 50 mm Small boxes of 1320 pieces
	<b>SERIES:</b> <b>ARTICLE:</b> <b>PACKAGE:</b>	DOMAL BREAK PA 63 <b>DU 314</b> Kinks in boxes 100 m
	<b>SERIES:</b> <b>ARTICLE:</b> <b>PACKAGE:</b>	DOMAL BREAK BILICO DOORS <b>EL 26</b> Boxes of 96 bars







# HYDRO

section	product specification		
	<b>SERIES:</b> <b>ARTICLE:</b> <b>PACKAGE:</b>	DOMAL STOPPER PG - DOMAL BREAK <b>C 956*</b> Rolls in boxes 800 m	<b>EL 12*</b> Rolls in boxes 800 m
	<b>SERIES:</b> <b>ARTICLE:</b> <b>PACKAGE:</b>	DOMAL 40 <b>C 1364*</b> Rolls in boxes 800 m	<b>EL 147</b> Rolls in boxes 300 m
	<b>SERIES:</b> <b>ARTICLE:</b> <b>PACKAGE:</b>	DOMAL 40 <b>DU 335*</b> Rolls in boxes 400 m	
	<b>SERIES:</b> <b>ARTICLE:</b> <b>PACKAGE:</b>	DOMAL 4 - 5 - 7 - 22 - 23 - 30 <b>C 312*</b> Rolls in boxes 1400 m	<b>F 182</b> - in flexible PVC Rolls in boxes 1400 m <b>EL 3*</b> Rolls in boxes 1400 m
	<b>SERIES:</b> <b>ARTICLE:</b> <b>PACKAGE:</b>	DOMALGELOSIA <b>C 1464*</b> Rolls in boxes 1200 m	<b>EL 145</b> Rolls in boxes 1200 m
	<b>SERIES:</b> <b>ARTICLE:</b> <b>PACKAGE:</b>	DOMAL GRID <b>DU 325</b> Rolls in boxes 300 m	
	<b>SERIES:</b> <b>ARTICLE:</b> <b>PACKAGE:</b>	DOMAL STOPPER PG <b>DU 380</b> Rolls in boxes 150 m	





# HYDRO

section	product specification	
	<b>SERIES:</b> <b>ARTICLE:</b> <b>PACKAGE:</b>	DOMAL SHUTTER <b>DU 390</b> Rolls in boxes 400 m
	<b>SERIES:</b> <b>ARTICLE:</b> <b>PACKAGE:</b>	DOMAL BREAK <b>DU 301</b> Rolls in boxes 300 m
	<b>SERIES:</b> <b>ARTICLE:</b> <b>PACKAGE:</b>	DOMAL DOORS - DOMAL STOPPER PG - DOMAL BREAK <b>DU 310</b> Rolls in boxes 100 m
	<b>SERIES:</b> <b>ARTICLE:</b> <b>PACKAGE:</b>	DOMAL STOPPER PG - DOMAL BREAK <b>EL 27*</b> Rolls in boxes 400 m
	<b>SERIES:</b> <b>ARTICLE:</b> <b>WORKING FIELD:</b> <b>PACKAGE:</b>	DOMAL STOPPER PG - DOMAL BREAK <b>DU 330*</b> 4 mm Rolls in boxes 200 m
	<b>SERIES:</b> <b>ARTICLE:</b> <b>WORKING FIELD:</b> <b>PACKAGE:</b>	DOMAL STOPPER PG - DOMAL BREAK <b>DU 350*</b> 3 mm Rolls in boxes 200 m
	<b>SERIES:</b> <b>ARTICLE:</b> <b>PACKAGE:</b>	DOMAL 4 - 5 <b>C 706*</b> Rolls in boxes 350 m

# HYDRO

section	product specification	
	<b>SERIES:</b> <b>ARTICLE:</b> <b>PACKAGE:</b>	DOMAL 4 - 5 <b>C 707*</b> Rolls in boxes 500 m
	<b>SERIES:</b> <b>ARTICLE:</b> <b>PACKAGE:</b>	DOMAL 4 - 5 <b>C 304</b> Rolls in boxes 600 m
	<b>SERIES:</b> <b>ARTICLE:</b> <b>PACKAGE:</b>	DOMAL 4 - 5 <b>C 305</b> Rolls in boxes 800 m
	<b>SERIES:</b> <b>ARTICLE:</b> <b>PACKAGE:</b>	DOMAL STOPPER PG - DOMAL BREAK <b>DU 360</b> Rolls in boxes 150 m
	<b>SERIES:</b> <b>ARTICLE:</b> <b>WORKING FIELD:</b> <b>PACKAGE:</b>	DOMAL STOPPER PG - DOMAL BREAK 11 <b>C 594*</b> 2 mm Rolls in boxes 400 m
	<b>SERIES:</b> <b>ARTICLE:</b> <b>PACKAGE:</b>	DOMAL 4-5 - DOMAL STOPPER PG - DOMAL BREAK <b>F 804*</b> Rolls in boxes 700 m
	<b>SERIES:</b> <b>ARTICLE:</b> <b>PACKAGE:</b>	DOMAL 7 <b>C 907</b> Rolls in boxes 350 m

# HYDRO

section	product specification	
	<b>SERIES:</b> <b>ARTICLE:</b> <b>PACKAGE:</b>	DOMALGELDSIA <b>C 1249*</b> <b>ARTICLE:</b> <b>EL 144</b> Rolls in boxes 800 m      Rolls in boxes 200 m
	<b>SERIES:</b> <b>ARTICLE:</b> <b>PACKAGE:</b>	DOMAL SLIDE - DOMAL BREAK PA 70 <b>DU 385</b> Rolls in boxes 100 m
	<b>SERIES:</b> <b>ARTICLE:</b> <b>PACKAGE:</b>	DOMAL STOPPER - DOMAL BREAK <b>DU 121*</b> Rolls in boxes 400 m
	<b>SERIES:</b> <b>ARTICLE:</b> <b>PACKAGE:</b>	DOMAL STOPPER - DOMAL BREAK <b>DU 313</b> Rolls in boxes 600 m

# METRA

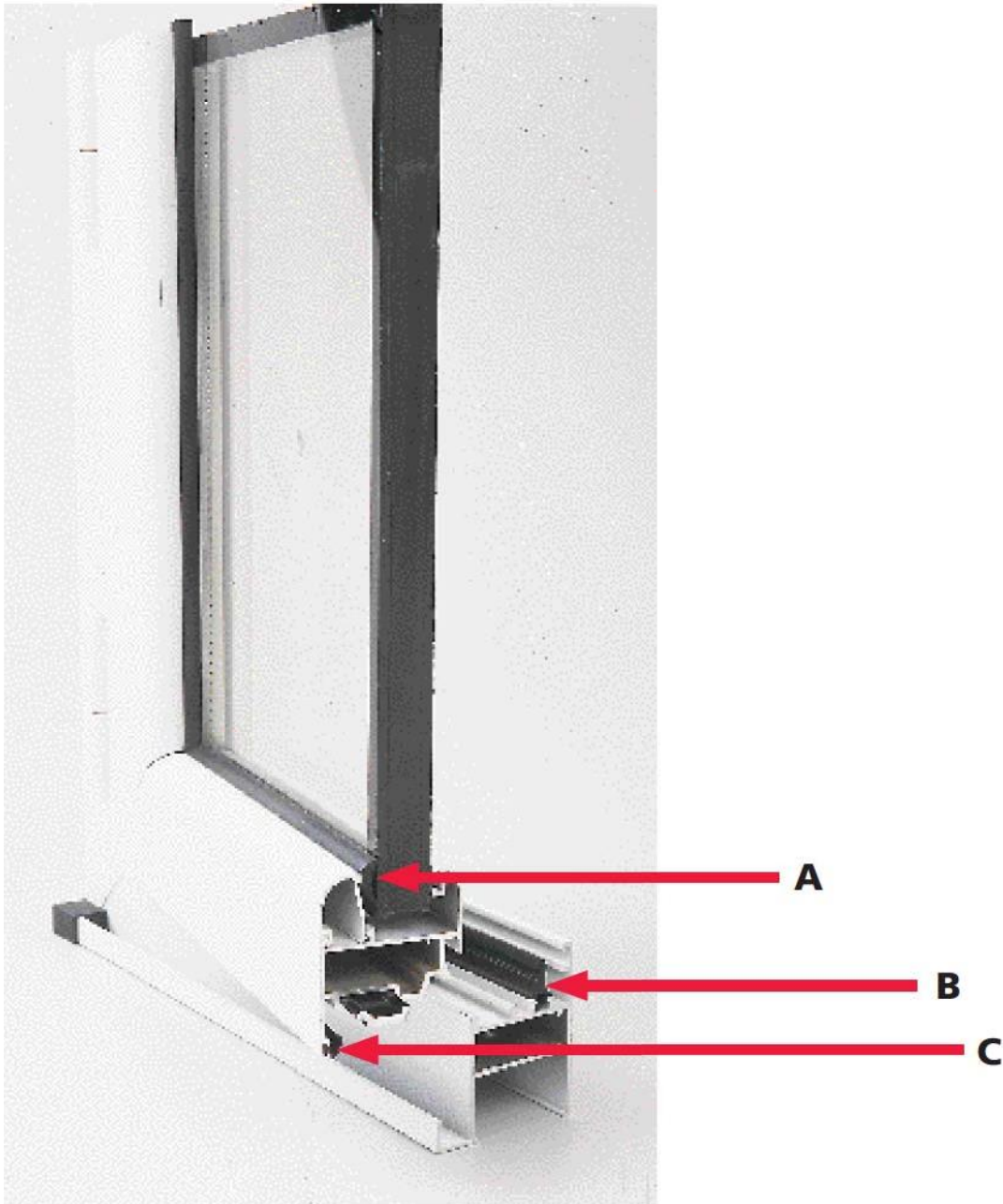

- A** glazing gasket
- B** central beating gasket
- C** inside beating gasket

# METRA

## LEGEND







- DU** seals in EPDM in conformity with the UNI 9122 regulation
- EL** seals in ELAPRENE in conformity with the UNI 9122/A regulation
- C** coextruded seals in PVC
- F** flexible seals in PVC in conformity with the UNI 9122 regulation
- R** rigid profiles in PVC

**ATTENTION:** according to standardization of packages, the size and the meter quantity may be subject to change.

\*in stock







section	product specification
	<p><b>SERIES:</b> NC 45 INT. - NC 55 INT.</p> <p><b>ARTICLE:</b> <b>DU 110*</b></p> <p><b>PACKAGE:</b> Kinks in boxes 150 m</p>
	<p><b>SERIES:</b> NC 45 INT.</p> <p><b>ARTICLE:</b> <b>DU 2007*</b> - Angle for DU 110</p> <p><b>DIMENSIONS:</b> 50 x 50 mm</p> <p><b>PACKAGE:</b> Small boxes of 2160 pieces</p>
	<p><b>SERIES:</b> NC 68 S.THERMIC</p> <p><b>ARTICLE:</b> <b>DU 165*</b></p> <p><b>PACKAGE:</b> Kinks in boxes 100 m</p>
	<p><b>SERIES:</b> NC 45 S.THERMIC</p> <p><b>ARTICLE:</b> <b>DU 190*</b></p> <p><b>PACKAGE:</b> Kinks in boxes 150 m</p>
	<p><b>SERIES:</b> NC 45 S.THERMIC</p> <p><b>ARTICLE:</b> <b>DU 2063*</b> - Angle for DU 190</p> <p><b>DIMENSIONS:</b> 40 x 40 mm</p> <p><b>PACKAGE:</b> Small boxes of 1800 pieces</p>
	<p><b>SERIES:</b> NC 40</p> <p><b>ARTICLE:</b> <b>C 649*</b></p> <p><b>PACKAGE:</b> Rolls in boxes 1200 m</p>

# METRA







section	product specification	
	<b>SERIES:</b> <b>ARTICLE:</b> <b>PACKAGE:</b>	NC 40 L <b>C 631</b> Rolls in boxes 1000 m
	<b>SERIES:</b> <b>ARTICLE:</b> <b>PACKAGE:</b>	NC 40 <b>C 381*</b> Rolls in boxes 1400 m
	<b>SERIES:</b> <b>ARTICLE:</b> <b>PACKAGE:</b>	NEW NC 40 <b>DU 105*</b> Rolls in boxes 200 m
	<b>SERIES:</b> <b>ARTICLE:</b> <b>PACKAGE:</b>	NEW NC 40 <b>C 1716</b> <b>EL 224</b> Rolls in boxes 400 m        Rolls in boxes 400 m
	<b>SERIES:</b> <b>ARTICLE:</b> <b>PACKAGE:</b>	NEW NC 40 <b>C 2173</b> <b>EL 283*</b> Rolls in boxes 500 m        Rolls in boxes 500 m <div style="float: right; border: 1px solid red; border-radius: 50%; padding: 5px; color: white; font-weight: bold;">NEW</div>
	<b>SERIES:</b> <b>ARTICLE:</b> <b>PACKAGE:</b>	NC 45 INT. - NC 55 INT. - NC 45 S.THERMIC <b>DU 125*</b> - Sealing weather-strip Rolls in boxes 300 m
	<b>SERIES:</b> <b>ARTICLE:</b> <b>PACKAGE:</b>	NC 35 FLAT - NC 45 INT. - NC 55 INT. <b>DU 121*</b> - Inside beating gasket Rolls in boxes 400 m





# METRA

section	product specification	
	<b>SERIES:</b> <b>ARTICLE:</b> <b>PACKAGE:</b>	NC 35 FLAT - NC 45 INT. - NC 55 INT. - NC 45 S.THERMIC <b>C 781*</b> Rolls in boxes 700 m
	<b>SERIES:</b> <b>ARTICLE:</b> <b>PACKAGE:</b>	NC 45 INT. - NC 55 INT. - NC 45 S.THERMIC - NC 70 INT. - NC 90 INT. <b>C 636</b> - Gasket for wall Rolls in boxes 700 m
	<b>SERIES:</b> <b>ARTICLE:</b> <b>WORKING FIELD:</b> <b>PACKAGE:</b>	NC 45 INT. - NC 55 INT. - NC 45 S.THERMIC - BALCONIES <b>DU 140*</b> 3 ÷ 4 mm Rolls in boxes 150 m
	<b>SERIES:</b> <b>ARTICLE:</b> <b>WORKING FIELD:</b> <b>PACKAGE:</b>	NC 45 INT. - NC 55 INT. - NC 45 S.THERMIC - BALCONIES <b>DU 130*</b> 2 ÷ 2.5 mm Rolls in boxes 200 m
	<b>SERIES:</b> <b>ARTICLE:</b> <b>WORKING FIELD:</b> <b>PACKAGE:</b>	NC 45 INT. - NC 55 INT. - NC 45 S.THERMIC <b>DU 152*</b> 2 mm Rolls in boxes 200 m
	<b>SERIES:</b> <b>ARTICLE:</b> <b>WORKING FIELD:</b> <b>PACKAGE:</b>	NC 45 INT. - NC 55 INT. - NC 45 S.THERMIC <b>DU 153*</b> 3 mm Rolls in boxes 200 m
	<b>SERIES:</b> <b>ARTICLE:</b> <b>WORKING FIELD:</b> <b>PACKAGE:</b>	NC 45 INT. - NC 55 INT. - NC 45 S.THERMIC <b>DU 154*</b> 4 mm Rolls in boxes 200 m

# METRA

section	product specification	
	<b>SERIES:</b> <b>ARTICLE:</b> <b>WORKING FIELD:</b> <b>PACKAGE:</b>	NC 45 INT. - NC 55 INT. - NC 45 S.THERMIC <b>DU 155*</b> 5 mm Rolls in boxes 150 m
	<b>SERIES:</b> <b>ARTICLE:</b> <b>WORKING FIELD:</b> <b>PACKAGE:</b>	NC 45 INT. - NC 55 INT. - NC 45 S.THERMIC <b>DU 156*</b> 6 mm Rolls in boxes 150 m
	<b>SERIES:</b> <b>ARTICLE:</b> <b>PACKAGE:</b>	NC 40 <b>C 1088</b> - for glass of 5 mm Rolls in boxes 400 m
	<b>SERIES:</b> <b>ARTICLE:</b> <b>PACKAGE:</b>	NC 40 <b>C 1089</b> - for glass of 4 mm Rolls in boxes 500 m
	<b>SERIES:</b> <b>ARTICLE:</b> <b>WORKING FIELD:</b> <b>PACKAGE:</b>	NC 45 INT. - NC 55 INT. - NC 45 S.THERMIC <b>DU 175*</b> 2 ÷ 3 mm Rolls in boxes 200 m
	<b>SERIES:</b> <b>ARTICLE:</b> <b>WORKING FIELD:</b> <b>PACKAGE:</b>	NC 45 INT. - NC 55 INT. - NC 45 S.THERMIC <b>DU 176*</b> 4 mm Rolls in boxes 200 m
	<b>SERIES:</b> <b>ARTICLE:</b> <b>WORKING FIELD:</b> <b>PACKAGE:</b>	CURTAIN WALLING <b>DU 145</b> 4 ÷ 5 mm Rolls in boxes 200 m

# METRA

section	product specification
	<p><b>SERIES:</b> CURTAIN WALLING  <b>ARTICLE:</b> <b>DU 146</b>  <b>WORKING FIELD:</b> 6 mm  <b>PACKAGE:</b> Rolls in boxes 100 m</p>
	<p><b>SERIES:</b> NC 45 INT. - NC 55 INT. - NC 45 S.THERMIC  <b>ARTICLE:</b> <b>F 804*</b> - Gasket for supplementary threshold profile  <b>PACKAGE:</b> Rolls in boxes 700 m</p>

# NEW-TEC Series

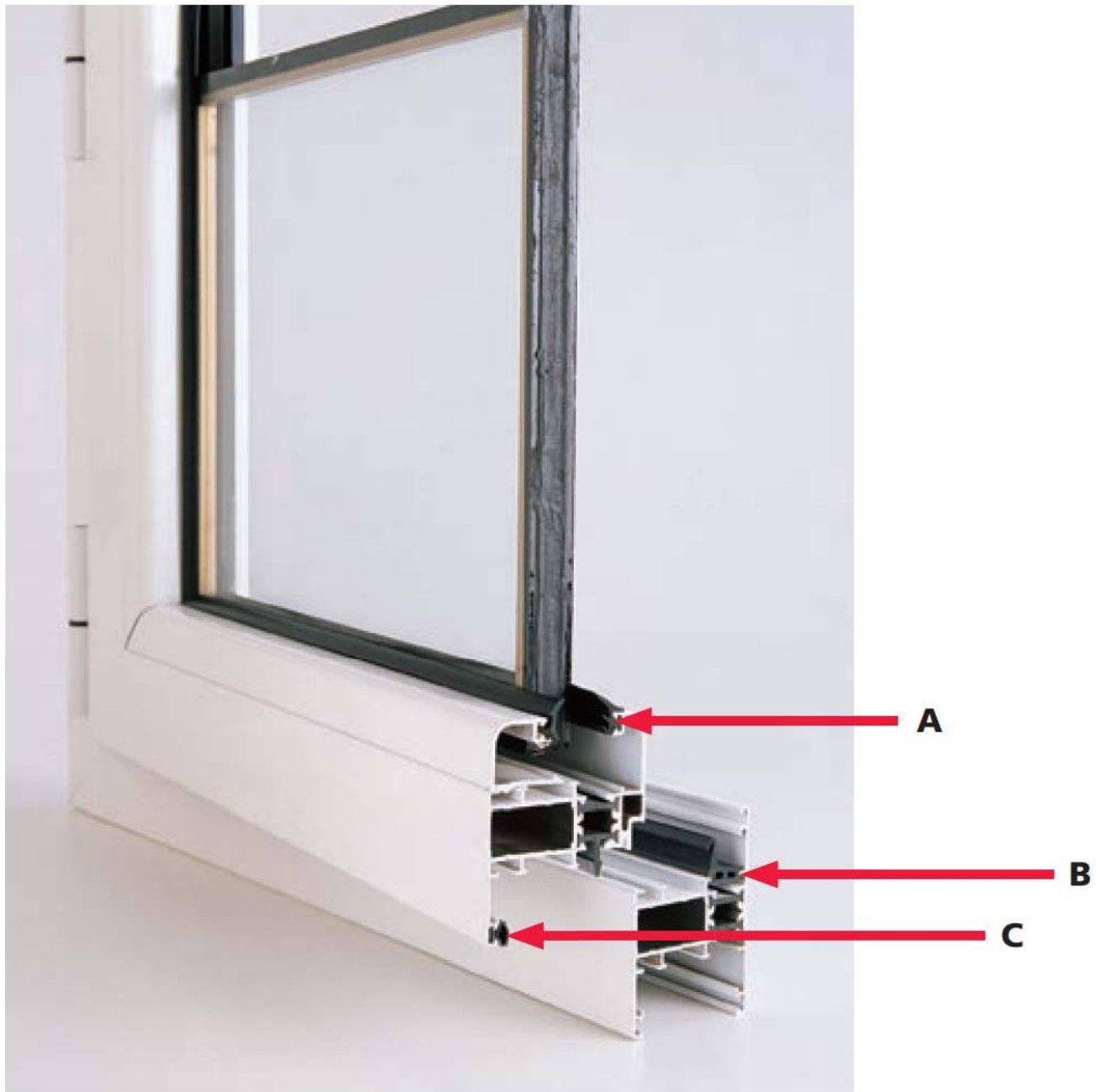

- A** glazing gasket
- B** central beating gasket
- C** inside beating gasket

# NEW-TEC Series

**LEGEND**





- DU** seals in EPDM in conformity with the UNI 9122 regulation
- EL** seals in ELAPRENE in conformity with the UNI 9122/A regulation
- C** coextruded seals in PVC
- F** flexible seals in PVC in conformity with the UNI 9122 regulation
- R** rigid profiles in PVC

**ATTENTION:** according to standardization of packages, the size and the meter quantity may be subject to change.

\*in stock

section	product specification	
	<b>SERIES:</b> NEW TEC <b>ARTICLE:</b> <b>DU 1069*</b> <b>PACKAGE:</b> Rolls in boxes 75 m	
	<b>SERIES:</b> NEW TEC <b>ARTICLE:</b> <b>DU 2010*</b> - Angle for DU 1069 <b>DIMENSIONS:</b> 50 x 50 mm <b>PACKAGE:</b> Small boxes of 1500 pieces	
	<b>SERIES:</b> NEW TEC <b>ARTICLE:</b> <b>C 825*</b> <b>PACKAGE:</b> Rolls in boxes 600 m	<b>EL 10*</b> Rolls in boxes 600 m
	<b>SERIES:</b> NEW TEC <b>ARTICLE:</b> <b>DU 210*</b> <b>PACKAGE:</b> Rolls in boxes 300 m	
	<b>SERIES:</b> NEW TEC <b>ARTICLE:</b> <b>DU 230*</b> <b>WORKING FIELD:</b> 3 mm <b>PACKAGE:</b> Rolls in boxes 150 m	
	<b>SERIES:</b> NEW TEC <b>ARTICLE:</b> <b>DU 152*</b> <b>WORKING FIELD:</b> 2 mm <b>PACKAGE:</b> Rolls in boxes 200 m	

# NEW-TEC Series

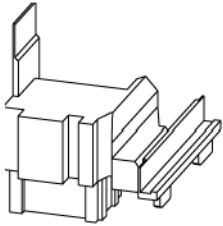
section	product specification
	<p><b>SERIES:</b> NEW TEC  <b>ARTICLE:</b> <b>DU 153*</b>  <b>WORKING FIELD:</b> 3 mm  <b>PACKAGE:</b> Rolls in boxes 200 m</p>
	<p><b>SERIES:</b> NEW TEC  <b>ARTICLE:</b> <b>DU 154*</b>  <b>WORKING FIELD:</b> 4 mm  <b>PACKAGE:</b> Rolls in boxes 200 m</p>
	<p><b>SERIES:</b> NEW TEC  <b>ARTICLE:</b> <b>DU 155*</b>  <b>WORKING FIELD:</b> 5 mm  <b>PACKAGE:</b> Rolls in boxes 150 m</p>
	<p><b>SERIES:</b> NEW TEC  <b>ARTICLE:</b> <b>DU 156*</b>  <b>WORKING FIELD:</b> 6 mm  <b>PACKAGE:</b> Rolls in boxes 150 m</p>
	<p><b>SERIES:</b> NEW TEC  <b>ARTICLE:</b> <b>DU 2100*</b> - Right and left cap of beating gasket reverse  <b>PACKAGE:</b> Boxes of 150 couples</p>

**NEW**

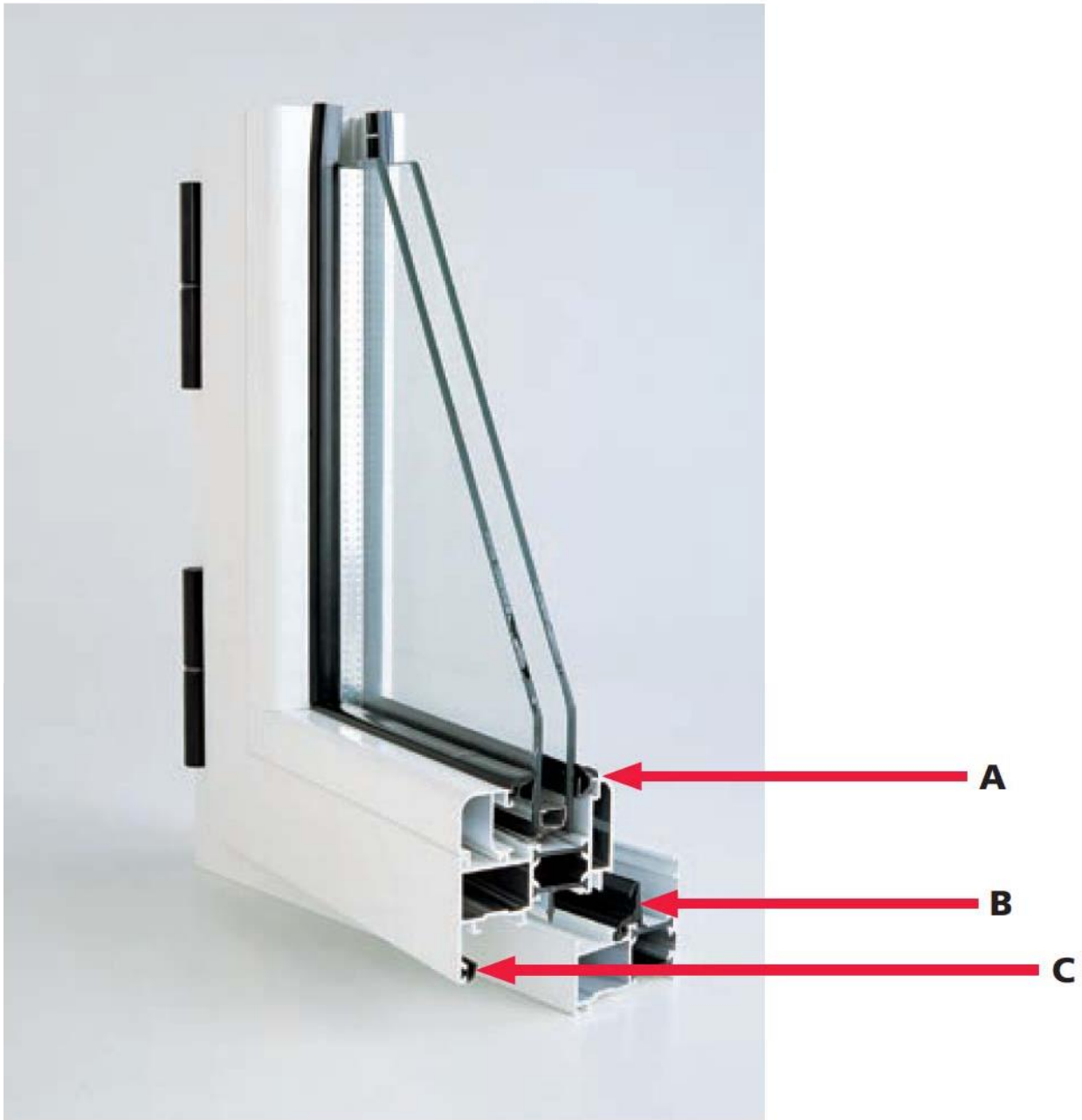
**PASSERINI**

- A** glazing gasket
- B** central beating gasket
- C** inside beating gasket





# PASSERINI

## LEGEND

- DU** seals in EPDM in conformity with the UNI 9122 regulation
- EL** seals in ELAPRENE in conformity with the UNI 9122/A regulation
- C** coextruded seals in PVC
- F** flexible seals in PVC in conformity with the UNI 9122 regulation
- R** rigid profiles in PVC



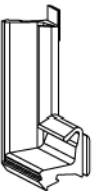



**ATTENTION:** according to standardization of packages, the size and the meter quantity may be subject to change.

\*in stock

section	product specification
	<p><b>SERIES:</b> EKIP 40  <b>ARTICLE:</b> <b>DU 400*</b>  <b>PACKAGE:</b> Kinks in boxes 180 m</p>
	<p><b>SERIES:</b> EKIP 50  <b>ARTICLE:</b> <b>DU 410</b>  <b>PACKAGE:</b> Rolls in boxes 100 m</p>
	<p><b>SERIES:</b> MAASTRICHT  <b>ARTICLE:</b> <b>DU 440*</b>  <b>PACKAGE:</b> Kinks in boxes 90 m</p>
	<p><b>SERIES:</b> MAASTRICHT  <b>ARTICLE:</b> <b>DU 2019*</b> - Angle for DU 440  <b>DIMENSIONS:</b> 50 x 50 mm  <b>PACKAGE:</b> Small boxes of 1104 pieces</p>
	<p><b>SERIES:</b> EKIP 40 - 50  <b>ARTICLE:</b> <b>DU 420</b> - Dust seal jointings  <b>PACKAGE:</b> Rolls in boxes 200 m</p>
	<p><b>SERIES:</b> EKIP 40 - 50  <b>ARTICLE:</b> <b>C 1130*</b> - Dust seal jointings  <b>PACKAGE:</b> Rolls in boxes 1000 m</p>



# PASSERINI

section	product specification	
	<b>SERIES:</b> <b>ARTICLE:</b> <b>PACKAGE:</b>	MAASTRICHT <b>DU 121*</b> Rolls in boxes 400 m
	<b>SERIES:</b> <b>ARTICLE:</b> <b>PACKAGE:</b>	EKIP 40 <b>C 1132*</b> Rolls in boxes 600 m
	<b>SERIES:</b> <b>ARTICLE:</b> <b>PACKAGE:</b>	EKIP 40 - 50 <b>C 1133*</b> - Gasket for frame Rolls in boxes 600 m
	<b>SERIES:</b> <b>ARTICLE:</b> <b>PACKAGE:</b>	EKIP 40 - 50 <b>DU 1247</b> Rolls in boxes 300 m
	<b>SERIES:</b> <b>ARTICLE:</b> <b>PACKAGE:</b>	EKIP 40 - 50 <b>C 1131*</b> Rolls in boxes 500 m
	<b>SERIES:</b> <b>ARTICLE:</b> <b>WORKING FIELD:</b> <b>PACKAGE:</b>	EKIP 40 - 50 <b>DU 1248</b> 2.5 mm Rolls in boxes 200 m
	<b>SERIES:</b> <b>ARTICLE:</b> <b>WORKING FIELD:</b> <b>PACKAGE:</b>	ALL <b>EL 15*</b> 1 mm Rolls in boxes 200 m

# PROFILATI

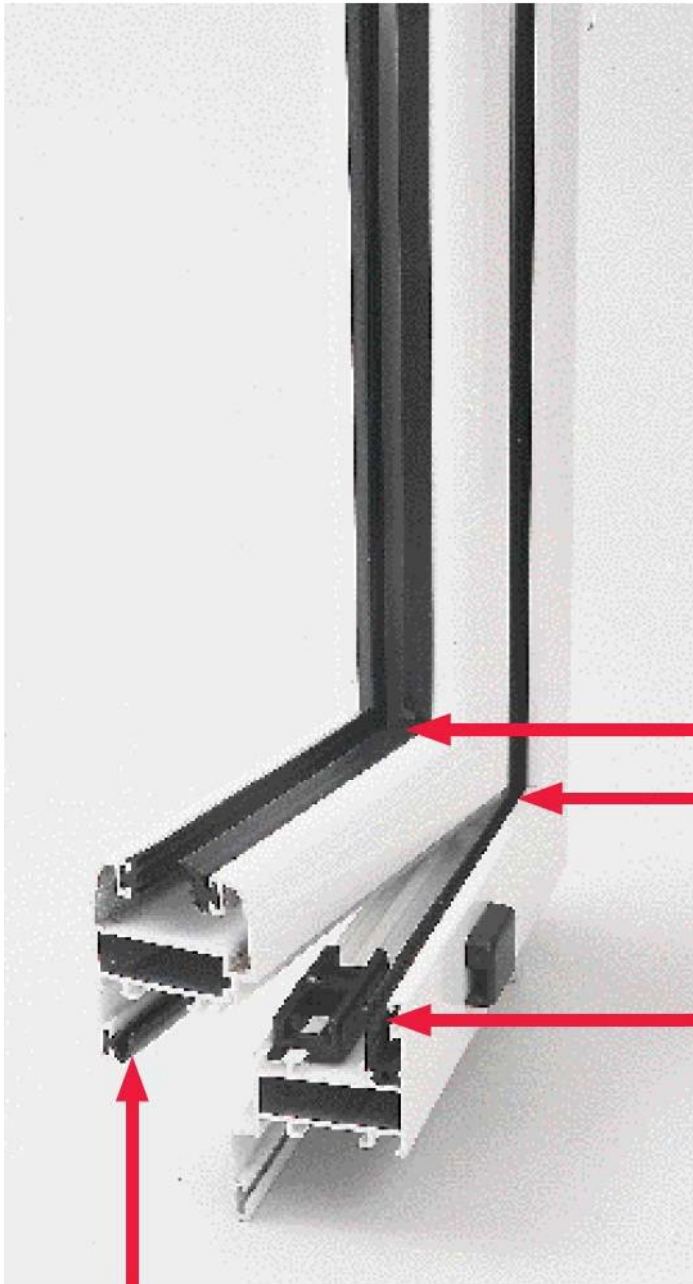
**C**

- A** glazing gasket
- B** central beating gasket
- C** inside beating gasket
- D** vulcanized angle

# PROFILATI

## LEGEND

- DU** seals in EPDM in conformity with the UNI 9122 regulation
- EL** seals in ELAPRENE in conformity with the UNI 9122/A regulation
- C** coextruded seals in PVC
- F** flexible seals in PVC in conformity with the UNI 9122 regulation
- R** rigid profiles in PVC

**ATTENTION:** according to standardization of packages, the size and the meter quantity may be subject to change.

\*in stock







section	product specification
	<p><b>SERIES:</b> EKV 53 - EKV 53 T.T.</p> <p><b>ARTICLE:</b> <b>DU 430*</b></p> <p><b>PACKAGE:</b> Kinks in boxes 180 m</p>
	<p><b>SERIES:</b> EKV 53 - EKV 53 T.T.</p> <p><b>ARTICLE:</b> <b>DU 2013*</b> - Angle for DU 430</p> <p><b>DIMENSIONS:</b> 50 x 50 mm</p> <p><b>PACKAGE:</b> Small boxes of 1800 pieces</p>
	<p><b>SERIES:</b> EKV 64 T.T.</p> <p><b>ARTICLE:</b> <b>DU 900*</b></p> <p><b>PACKAGE:</b> Kinks in boxes 120 m</p>
	<p><b>SERIES:</b> EKV 64 T.T.</p> <p><b>ARTICLE:</b> <b>DU 2015*</b> - Angle for DU 900</p> <p><b>DIMENSIONS:</b> 50 x 50 mm</p> <p><b>PACKAGE:</b> Small boxes of 1200 pieces</p>
	<p><b>SERIES:</b> EKV 72 T.T.</p> <p><b>ARTICLE:</b> <b>DU 901</b></p> <p><b>PACKAGE:</b> Rolls in boxes 90 m</p>
	<p><b>SERIES:</b> SYSTEM 1 COMPLANER AND EXPOSURE</p> <p><b>ARTICLE:</b> <b>DU 1082</b></p> <p><b>PACKAGE:</b> Kinks in boxes 150 m</p>

**NEW**

# PROFILATI

section	product specification	
	<b>SERIES:</b> SYSTEM 1 COMPLANER AND EXPOSURE <b>ARTICLE:</b> <b>C 1434*</b> <b>PACKAGE:</b> Rolls in boxes 250 m	<b>EL 143*</b> Rolls in boxes 250 m
	<b>SERIES:</b> EKU 53 - EKU 53 T.T. - EKU 64 T.T. - EKU 72 T.T. <b>ARTICLE:</b> <b>C 956*</b> <b>PACKAGE:</b> Rolls in boxes 800 m	<b>EL 12*</b> Rolls in boxes 800 m
	<b>SERIES:</b> EKU 53 - EKU 53 T.T. - EKU 64 T.T. - EKU 72 T.T. <b>ARTICLE:</b> <b>DU 121*</b> <b>PACKAGE:</b> Rolls in boxes 400 m	
	<b>SERIES:</b> EKU 53 - EKU 53 T.T. - EKU 64 T.T. - EKU 72 T.T. <b>ARTICLE:</b> <b>DU 350*</b> <b>WORKING FIELD:</b> 3 mm <b>PACKAGE:</b> Rolls in boxes 200 m	
	<b>SERIES:</b> EKU 53 - EKU 53 T.T. - EKU 64 T.T. - EKU 72 T.T. <b>ARTICLE:</b> <b>DU 330*</b> <b>WORKING FIELD:</b> 4 mm <b>PACKAGE:</b> Rolls in boxes 200 m	
	<b>SERIES:</b> EKU 53 - EKU 64 T.T. - EKU 72 T.T. <b>ARTICLE:</b> <b>DU 13*</b> <b>WORKING FIELD:</b> 3 mm <b>PACKAGE:</b> Rolls in boxes 400 m	
	<b>SERIES:</b> EKU 53 - EKU 64 T.T. - EKU 72 T.T. <b>ARTICLE:</b> <b>DU 15*</b> <b>WORKING FIELD:</b> 5 mm <b>PACKAGE:</b> Rolls in boxes 200 m	

# PROFILATI

section	product specification	
	<b>SERIES:</b> <b>ARTICLE:</b> <b>WORKING FIELD:</b> <b>PACKAGE:</b>	EKU 53 - EKU 64 T.T. - EKU 72 T.T. <b>DU 17*</b> 7 mm Rolls in boxes 120 m
	<b>SERIES:</b> <b>ARTICLE:</b> <b>WORKING FIELD:</b> <b>PACKAGE:</b>	SYSTEM 1 - EKU 53 - EKU 64 T.T. - EKU 72 T.T. <b>DU 152*</b> 2 mm Rolls in boxes 200 m
	<b>SERIES:</b> <b>ARTICLE:</b> <b>WORKING FIELD:</b> <b>PACKAGE:</b>	SYSTEM 1 - EKU 53 - EKU 64 T.T. - EKU 72 T.T. <b>DU 153*</b> 3 mm Rolls in boxes 200 m
	<b>SERIES:</b> <b>ARTICLE:</b> <b>WORKING FIELD:</b> <b>PACKAGE:</b>	SYSTEM 1 - EKU 53 - EKU 64 T.T. - EKU 72 T.T. <b>DU 154*</b> 4 mm Rolls in boxes 200 m
	<b>SERIES:</b> <b>ARTICLE:</b> <b>WORKING FIELD:</b> <b>PACKAGE:</b>	SYSTEM 1 - EKU 53 - EKU 64 T.T. - EKU 72 T.T. <b>DU 155*</b> 5 mm Rolls in boxes 150 m
	<b>SERIES:</b> <b>ARTICLE:</b> <b>WORKING FIELD:</b> <b>PACKAGE:</b>	SYSTEM 1 - EKU 53 - EKU 64 T.T. - EKU 72 T.T. <b>DU 156*</b> 6 mm Rolls in boxes 150 m
	<b>ARTICLE:</b> <b>PACKAGE:</b>	<b>DU 1458</b> - Seal for aluminium door Rolls in boxes 50 m <div data-bbox="1300 1892 1436 1960" style="float: right; border: 1px solid red; border-radius: 50%; padding: 2px 5px; color: white; font-weight: bold;">NEW</div>

# POLYAMIDE STRIPS FOR CREMONE

**ATTENTION:** according to standardization of packages, the size and the meter quantity may be subject to change.

## LEGEND

**N** polyamide strips with fibreglass

\*in stock

section	product specification
	<p><b>ARTICLE:</b> <b>N 2014*</b> - Strip for cremone for standard size frame  <b>PACKAGE:</b> Rolls in boxes 250 m - Rolls in boxes 150 m - Boxes of 100 bars of 3000 mm</p>
	<p><b>SERIES:</b> Alcoa R 40  <b>ARTICLE:</b> <b>N 2015*</b>  <b>PACKAGE:</b> Rolls in boxes 200 m - Boxes of 100 bars of 3000 mm</p>

# POLYAMIDE STRIPS for thermal break

**ATTENTION:** according to standardization of packages, the size and the meter quantity may be subject to change.

## LEGEND

**N** polyamide strips with fibreglass

\*in stock

section	product specification
	<b>ARTICLE:</b> N 2002 <b>PACKAGE:</b> Bundles of 100 bars
	<b>ARTICLE:</b> N 2008 <b>PACKAGE:</b> Bundles of 100 bars
	<b>ARTICLE:</b> N 2009 <b>PACKAGE:</b> Bundles of 100 bars
	<b>ARTICLE:</b> N 2010 <b>PACKAGE:</b> Bundles of 50 bars
	<b>ARTICLE:</b> N 2011 <b>PACKAGE:</b> Bundles of 50 bars
	<b>ARTICLE:</b> N 2012 - with glue <b>PACKAGE:</b> Bundles of 50 bars

# POLYAMIDE STRIPS for thermal break

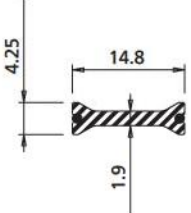
section	product specification
	<p><b>ARTICLE:</b> N 2013 - with glue  <b>PACKAGE:</b> Bundles of 100 bars</p>



**LEGEND**

**DU** seals in EPDM in conformity with the UNI 9122 regulation  
**C** coextruded seals in PVC

**ATTENTION:** according to standardization of packages, the size and the meter quantity may be subject to change.

\*in stock

**GASKETS FOR PROFILES IN IRON AND STEEL**

section	product specification
	<b>ARTICLE:</b> C 1323 - with biadheseive <b>PACKAGE:</b> Boxes of 175 bars of 2500 mm
	<b>ARTICLE:</b> C 1405* - with biadheseive <b>PACKAGE:</b> Boxes of 180 bars of 2500 mm
	<b>ARTICLE:</b> C 2076 - with biadheseive <b>PACKAGE:</b> Boxes of 180 bars

**NEW**





**GASKETS OF PROTECTION FOR EASELS**

section	product specification
	<b>ARTICLE:</b> DU 1277* <b>PACKAGE:</b> Kinks in boxes 80 m

**UNIVERSAL SUPPORT-GASKET FOR EXTERNAL GLASS**

section	product specification
	<b>ARTICLE:</b> DU 1077 <b>PACKAGE:</b> Rolls in boxes 800 m

## RIGID PIPES

section	product specification
	<p><b>ARTICLE:</b> R 2149*</p> <p><b>PACKAGE:</b> Boxes of 100 bars of 3000 mm</p> 
	<p><b>ARTICLE:</b> R 2205*</p> <p><b>PACKAGE:</b> Boxes of 100 bars of 3000 mm</p> 

## CYANOACRYLATE ADHESIVE

section	product specification
	<p><b>ARTICLE:</b> CYANOACRYLATE ADHESIVE*</p> <p><b>PACKAGE:</b> 10 bottles of 20 gr</p>

# JOINTING FOR SHUTTERS

**LEGEND**

- DU** seals in EPDM in conformity with the UNI 9122 regulation
- EL** seals in ELAPRENE in conformity with the UNI 9122/A regulation
- C** coextruded seals in PVC
- F** flexible seals in PVC in conformity with the UNI 9122 regulation
- R** rigid profiles in PVC

**ATTENTION:** according to standardization of packages, the size and the meter quantity may be subject to change.

\*in stock

section	product specification
	<b>SERIES:</b> NACO <b>ARTICLE:</b> <b>C 1394*</b> - Gasket for thin plate <b>PACKAGE:</b> Rolls in boxes 800 m
	<b>ARTICLE:</b> <b>C 1294</b> - Gasket for thin plate <b>PACKAGE:</b> Rolls in boxes 1500 m
	<b>SERIES:</b> FLASH <b>ARTICLE:</b> <b>C 1352</b> - Gasket for thin plate <b>PACKAGE:</b> Rolls in boxes 150 m
	<b>SERIES:</b> MIXER <b>ARTICLE:</b> <b>C 1349</b> - Gasket for thin plate <b>PACKAGE:</b> Rolls in boxes 250 m
	<b>SERIES:</b> ERMES <b>ARTICLE:</b> <b>C 1387</b> - Gasket for thin plate <b>PACKAGE:</b> Rolls in boxes 800 m
	<b>SERIES:</b> UNIVERSAL 55 - PERLA 70 <b>ARTICLE:</b> <b>EL 153*</b> <b>C 1779*</b> <b>PACKAGE:</b> Rolls in boxes 1200 m      Rolls in boxes 1200 m

**NEW**

# PROFILES FOR CURTAIN WALLS

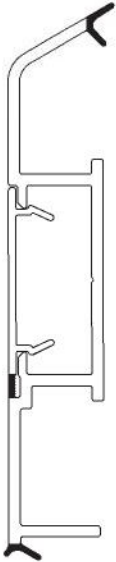
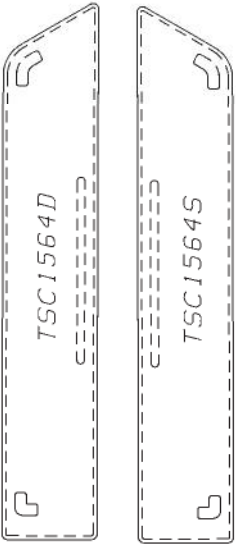
section	product specification
	<p><b>SERIES:</b> CURTAIN WALL  <b>ARTICLE:</b> <b>C 1564 - Cable trunking skirting board profile</b>  <b>PACKAGE:</b> Boxes of 17 bars</p>
	<p><b>SERIES:</b> CURTAIN WALL  <b>ARTICLE:</b> <b>TSC 1564 D - Right cap for C 1564</b>  <b>PACKAGE:</b> Bags of 500 pieces</p> <p><b>SERIES:</b> CURTAIN WALL  <b>ARTICLE:</b> <b>TSC 1564 S - Left cap for C 1564</b>  <b>PACKAGE:</b> Bags of 500 pieces</p>

# DUST SEAL BRUSHES FOR SLIDING WINDOWS AND MOSQUITO NETS

**ATTENTION:** according to standardization of packages, the size and the meter quantity may be subject to change.

**LEGEND**

- DIMENSIONS:** b = base  
h = pile height
- SEAL PILE:** brush
- SEAL FILM:** brush with central separator

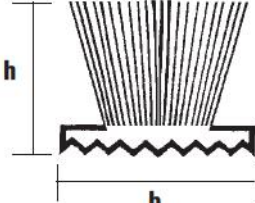
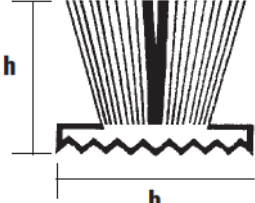
section	product specification
 <p><b>BRUSH (SEAL PILE)</b></p>	<p><b>ARTICLE:</b> SPASP 4.8X5 3P SEAL PILE</p> <p><b>DIMENSIONS:</b> b 4.8 mm - h 5 mm</p> <p><b>COLOURS:</b> Black</p> <p><b>PACKAGE:</b> Boxes of 1800 m (4 rolls of 450 m)</p>
	<p><b>ARTICLE:</b> SPASP 4.8X7 3P SEAL PILE</p> <p><b>DIMENSIONS:</b> b 4.8 mm - h 7 mm</p> <p><b>COLOURS:</b> Black</p> <p><b>PACKAGE:</b> Boxes of 1300 m (4 rolls of 325 m)</p>
	<p><b>ARTICLE:</b> SPASP 4.8X8 3P SEAL PILE</p> <p><b>DIMENSIONS:</b> b 4.8 mm - h 8 mm</p> <p><b>COLOURS:</b> Black</p> <p><b>PACKAGE:</b> Boxes of 1100 m (4 rolls of 275 m)</p>
	<p><b>ARTICLE:</b> SPASP 4.8X11 3P SEAL PILE</p> <p><b>DIMENSIONS:</b> b 4.8 mm - h 11 mm</p> <p><b>COLOURS:</b> Black</p> <p><b>PACKAGE:</b> Boxes of 600 m (3 rolls of 200 m)</p>
	<p><b>ARTICLE:</b> SPASP 6.9X5 3P SEAL PILE</p> <p><b>DIMENSIONS:</b> b 6.9 mm - h 5 mm</p> <p><b>COLOURS:</b> Black</p> <p><b>PACKAGE:</b> Boxes of 1500 m (4 rolls of 375 m)</p>
 <p><b>BRUSH WITH CENTRAL SEPARATOR (SEAL FILM)</b></p>	<p><b>ARTICLE:</b> SPASP 6.9X5.5 3P SEAL PILE</p> <p><b>DIMENSIONS:</b> b 6.9 mm - h 5.5 mm</p> <p><b>COLOURS:</b> Black</p> <p><b>PACKAGE:</b> Boxes of 1300 m (4 rolls of 325 m)</p>
	<p><b>ARTICLE:</b> SPASF 4.8X5.5 2P SEAL FILM</p> <p><b>DIMENSIONS:</b> b 4.8 mm - h 5.5 mm</p> <p><b>COLOURS:</b> Black</p> <p><b>PACKAGE:</b> Boxes of 700 m (7 rolls of 100 m)</p>
	<p><b>ARTICLE:</b> SPASF 6.9X5.5 4P SEAL FILM</p> <p><b>DIMENSIONS:</b> b 6.9 mm - h 5.5 mm</p> <p><b>COLOURS:</b> Black</p> <p><b>PACKAGE:</b> Boxes of 700 m (7 rolls of 100 m)</p>

gruppo  
**BMP**

**RUBBER SEALS PRODUCTION INDUSTRY**

**Head Offices:** Serres Industrial Area, P.O. BOX 1146, 62110 Serres, Greece

**Branch:** Kilkis Industrial Area, Block 8A, 61100 Kilkis, Greece

**T:** (0030) 23210 77088, **F:** (0030) 23210 77089, **E:** [bmp@bmp.com.gr](mailto:bmp@bmp.com.gr), **W:** [www.bmp.com.gr](http://www.bmp.com.gr)